



MICHAEL PHELPS
LEGEND[®]

 BY MASTER SPAS



Michael Phelps

2025
OWNER'S MANUAL
AND LIMITED WARRANTY

MASTER SPAS OWNER'S MANUAL

Welcome to the Ultimate in Relaxation!

Thank you for choosing your new spa built by Master Spas. For how-to videos and helpful tips on operating and maintaining your spa, please visit www.masterspas.com/resources.

Please read the entire Owner's Manual before installing and using your spa. The goal of this manual is to provide you with safety and operational information plus some tips that will help you enjoy your spa to its fullest. At the time of print, this manual is accurate in its information. Master Spas reserves the right to change or improve its product without prior notice.

REGISTER YOUR SPA

Please be sure to register your spa so we can efficiently assist with any questions you may have. Until your spa has been registered, Master Spas will not have record of your ownership. To register your spa, visit www.masterspas.com/resources and click on Spa Registration.

SERIAL NUMBER LOCATION

The serial number for your spa is located near the filter area, on the spa system pack, or on the listing plate on the spa frame behind the front skirt panel. It is a seven digit number on most models or an "R" followed by 6 digits. For example, 2512345 or R251234.

RECORD OF OWNERSHIP

Name _____

Address _____

City _____ State _____ Zip _____

Phone Number (_____) _____ - _____ Date Purchased ____ / ____ / ____

Model _____ Serial # _____

Dealer Name _____

Service Tech Rep _____



WATCH HOW-TO VIDEOS:
masterspas.com/video-tutorials



RELAX. IT'S

Master Spas®

6927 Lincoln Parkway
Fort Wayne, IN 46804
masterspas.com

TABLE OF CONTENTS

Safety Instructions	2-10
Compliance	11
VGB Suction Safety & Maintenance Instructions	12-13
Glossary of Spa Terminology	14-16
The Advantages of EcoPur® Charge	17-18
Water Chemistry Terms You Should Know	19-20
Why Are Chemicals Important in a Spa	21
Water Maintenance	22-25
Recommended Ranges.....	22
Start-Up.....	23
Schedule.....	24
Troubleshooting Guide.....	25
Regular Maintenance Procedures	26-33
Spa Troubleshooting Guide	34-35
Winterizing & Storing Your Spa	36
Model Specifications	37
Installation Instructions	38-47
Site Preparation/General Guidelines.....	38-40
Electrical Requirements.....	41-42
Skirt Cabinet Panel Removal.....	43-45
Initial Spa Setup.....	46-47
Operating Instructions	48-71
Spa Controls - GECKO in.k1000+.....	48-67
Spa Controls - Pump Diagrams.....	68-71
Master Clear Salt System	72-73
Fusion Air Sound System (if equipped)	74-78
GECKO in.k1000+ Wi-Fi (if equipped)	79
Cabinet Light	80
Master3rPur™	81-83
Limited Warranty	84-87
Spa Care & Maintenance Record	88

SAVE THESE INSTRUCTIONS

Included with your new spa is a safety sign. The sign is for you and your guest's protection and is suitable for outdoor use in wet locations. The sign should be placed in a location visible to all users of the spa.

Please take time to point out the physical location of the safety sign and the importance of the safety precautions displayed on the safety sign to all of your guests. Remember, your safety and the safety of anyone who enjoys the use of your spa is our utmost concern.

The sign should be mounted with screws or another type of permanent fastener. Additional or replacement signs can be obtained from your dealer or direct from the factory.

INTRODUCTION

It's time to relax! You now have your very own portable spa by Master Spas. By fully understanding the operation of each of the features of your new Master Spa, you will be assured of many years of hassle-free, hot water therapy and fun.

Your safety is of paramount importance to the Master Spas family. We urge you to carefully read, understand, and follow all information in this user manual before installing and using the spa. These warnings, instructions, and safety guidelines address some common risks of water recreation, but they cannot cover all risks and dangers in all cases. Always use caution, common sense, and good judgment when enjoying any water activity. Retain this information for future use.

Through reading and totally understanding the important information in your owner's manual, you will realize that you now own **THE ULTIMATE RELAXATION MACHINE!**[®]



Safety graphical symbol ISO 7010, M002 – Refer to instruction manual/booklet

NO DIVING

**DANGER: DIVING MAY
RESULT IN SERIOUS
INJURY OR DEATH.**



IMPORTANT SAFETY INSTRUCTIONS

This spa is not intended for public/commercial use.

When installing and using this electrical equipment, basic safety precautions should be observed including the following:

READ AND FOLLOW ALL INSTRUCTIONS

WARNING – To reduce the risk of injury, do not permit children to use this product unless they are closely supervised at all times.

A wire conductor is provided on this unit to connect a minimum 10AWG (5.26mm²) solid copper conductor between this unit and any metal equipment, metal enclosures of electrical equipment, metal water pipe, or conduit within 5 feet (1.5m) of the unit.

(For cord-connected/convertible units)

DANGER – Risk of injury.

- a) Replace damaged cord immediately.
- b) Do not bury cord.
- c) Connect to a grounded, grounding type receptacle only.

(For units intended for indoor use only)

WARNING – For indoor use only. This unit is not intended for outdoor use.

(For units intended for outdoor use only)

WARNING – For outdoor use only. This unit is not intended for indoor use.

NO DIVING **DANGER: DIVING MAY
RESULT IN SERIOUS
INJURY OR DEATH.**



IMPORTANT SAFETY INSTRUCTIONS (CONT.)

(For units with GFCI)

WARNING – This product is provided with a ground-fault circuit interrupter located on the front panel of selected swim spas and on the power cord of 120 volt convertible spas. The GFCI must be tested before each use. With the product operating, open the service door. When the product stops operating, this merely indicates that the door is equipped with an electrical interlock. Next, push the test button on the GFCI and close the service door. The product should not operate. Now open the service door, push the reset button on the GFCI and close the service door. The product should now operate normally. When the product fails to operate in this manner, there is a ground current flowing indicating the possibility of an electric shock. Disconnect the power until the fault has been identified and corrected.

DANGER – Risk of Accidental Drowning. Extreme caution must be exercised to prevent unauthorized access by children. To avoid accidents, ensure that children cannot use this spa unless they are supervised at all times.

DANGER – Risk of Injury. The suction fittings in this spa are sized to match the specific water flow created by the pump. Should the need arise to replace the suction fittings or the pump, be sure that the flow rates are compatible. Never operate spa if the suction fittings are broken or missing. Never replace a suction fitting with one rated less than the flow rate marked on the original suction fitting.

DANGER – Risk of Electric Shock. Install at least 5 feet (1.5m) from all metal surfaces. As an alternative, a spa may be installed within 5 feet of metal surfaces if each metal surface is permanently connected by a minimum 10AWG (5.26mm²) solid copper conductor to the wire connector on the terminal box that is provided for this purpose. Be sure to review and comply with any overruling local or national applicable regulations.

DANGER – Risk of Electric Shock. Do not permit any electric appliance, such as a light, telephone, radio, or television, within 5 feet (1.5 m) of a spa.

WARNING – To reduce the risk of injury:

- a) The water in a spa should never exceed 104 °F (40 °C). Water temperatures between 100 °F (38 °C) and 104 °F (40 °C) are considered safe for a healthy adult. Lower water temperatures are recommended for young children and when spa use exceeds 10 minutes. Persons with any medical condition should seek medical advice before using a spa.

<h1>NO DIVING</h1>	DANGER: DIVING MAY RESULT IN SERIOUS INJURY OR DEATH.	
--------------------	--	---

IMPORTANT SAFETY INSTRUCTIONS (CONT.)

- b) Since excessive water temperatures have a high potential for causing fetal damage during the early months of pregnancy, pregnant or possibly pregnant women should limit spa water temperatures to 100°F (38°C) and duration of use and should also seek medical advice.
- c) Before entering a spa, the user should measure the water temperature with an accurate thermometer since the tolerance of water temperature-regulating devices varies.
- d) The use of alcohol, drugs, or medication before or during spa use may lead to unconsciousness with the possibility of drowning.
- e) Obese persons and persons with a history of heart disease, low or high blood pressure, circulatory system problems, or diabetes should consult a physician before using a spa.
- f) Persons using medication should consult a physician before using a spa since some medication may induce drowsiness while other medication may affect heart rate, blood pressure, and circulation.

(For spas with a gas heater)

WARNING – Risk of Suffocation. This spa is equipped with a gas heater and is intended for outdoor use only unless proper ventilation can be provided for an indoor installation.

SAVE THESE INSTRUCTIONS

HYPERTHERMIA

Hyperthermia occurs when the internal temperature of the body reaches a level several degrees above the normal body temperature of 98.6°F (37°C). Prolonged immersion in hot water may induce hyperthermia.

THE SYMPTOMS OF HYPERTHERMIA INCLUDE:

- Dizziness • Fainting • Drowsiness • Lethargy
- Increase in Internal Body Temperature

THE EFFECTS OF HYPERTHERMIA INCLUDE:

Unawareness of Impending Hazard • Failure to Perceive Heat • Failure to Recognize the Need to Exit Spa • Physical Inability to Exit Spa • Fetal Damage in Pregnant Women • Unconsciousness Resulting in a Danger of Drowning

WARNING – The use of alcohol, drugs, or medication can greatly increase the risk of hyperthermia.



IMPORTANT SAFETY INSTRUCTIONS (CONT.)

DANGER – To reduce the risk of injury to persons, do not remove the suction grate. Suction through drains and skimmers is powerful when the jets in the spa are in use. Damaged covers can be hazardous to small children and adults with long hair. Should any part of the body be drawn into these fittings, turn off the spa immediately. As a precaution, long hair should not be allowed to float in the spa.



EN 17125 – Do not put finger in massage jet

WARNING – Install the spa so that water can be easily drained out of the compartment containing electrical components so as not to damage equipment. When installing the spa make sure to allow for an adequate drainage system to deal with any overflow water. Please allow for at least 3 feet of clearance around the perimeter of the spa to provide enough room to access for servicing. Contact your local dealer for their specific requirements.

WARNING – The spa should be covered with an approved locking cover when not in use, to prevent unauthorized entry and injuries.

WARNING – People with infections, sores or the like should not use the spa. Warm and hot water temperatures may allow the growth of infectious bacteria if not properly disinfected.

CAUTION – Safe temperatures for swimming or aquatic exercise is around 80°F (26.7°C).

CAUTION – Risk of Electrical Shock. Do not leave audio compartment open. Audio CD controls are not to be operated while inside the spa.

CAUTION – Replace components only with identical components.

WARNING – Risk of Electric Shock. Do not connect any auxiliary components (for example, additional speakers, headphones, additional audio/ video components etc.) to the system. These units are not provided with an outdoor antenna.

Do not service this product yourself as opening or removing covers may expose you to dangerous voltage or other hazards. Refer all servicing to qualified service personnel. If the power supply cord(s) are damaged, water is entering the speaker, audio compartment, or any other component in the electrical equipment compartment area, the protective shield is showing signs of deterioration, or there are signs of other potentially hazardous damage to the unit, turn off the circuit breaker from the wall and refer servicing to qualified personnel.

NO DIVING	DANGER: DIVING MAY RESULT IN SERIOUS INJURY OR DEATH.	
------------------	--	---

IMPORTANT SAFETY INSTRUCTIONS (CONT.)

The unit should be subjected to periodic routine maintenance once every quarter to make sure that the it is operating properly.

DANGER – Risk of Electric Shock. A green colored terminal or a terminal marked G, GR, Ground, Grounding or the symbol shown in Figure 14.1 of UL 1563 is located inside the supply terminal box or compartment. To reduce the risk of electric shock, this terminal must be connected to the grounding means provided in the electric supply service panel with a continuous copper wire equivalent in size to the circuit conductors supplying this equipment.

At least two lugs marked “Bonding Lugs” are provided on the external surface or on the inside of the supply terminal box or compartment. To reduce the risk of electric shock, connect the local common bonding grid in the area of the spa to these terminals with an insulated or bare copper conductor not smaller than 10AWG.

All field installed metal components such as rails, ladders, drains, or other similar hardware within 10 feet (3m) of the spa shall be bonded to the equipment grounding bus with copper conductors not smaller than 10AWG.

SAVE THESE INSTRUCTIONS

SAFETY INSTRUCTIONS

WARNING: CHILDREN SHOULD NOT USE SPAS OR HOT TUBS WITHOUT ADULT SUPERVISION.

AVERTISSEMENT: NE PAS LAISSER LES ENFANTS UTILISER UNE CUVE DE RELAXATION SANS SURVEILLANCE.

WARNING: DO NOT USE SPAS OR HOT TUBS UNLESS ALL SUCTION GUARDS ARE INSTALLED TO PREVENT BODY AND HAIR ENTRAPMENT.

AVERTISSEMENT: POUR ÉVITER QUE LES CHEVEUX OU UNE PARTIE DU CORPS PUISSENT ÊTRE ASPIRES, NE PAS UTILISER UNE CUVE DE RELAXATION SI LES GRILLES DI PRISE D'ASPIRATION NE SONT PAS TOUTES EN PLACE.

WARNING: PEOPLE USING MEDICATIONS AND/OR HAVING AN ADVERSE MEDICAL HISTORY SHOULD CONSULT A PHYSICIAN BEFORE USING A SPA OR HOT TUB.

AVERTISSEMENT: LES PERSONNES QUI PRENNENT DES MÉDICAMENTS OU ONT DES PROBLÈMES DE SANTÉ DEVRAIENT CONSULTER UN MÉDECIN AVANT D'UTILISER UNE CUVE DE RELAXATION.

WARNING: PEOPLE WITH INFECTIOUS DISEASES SHOULD NOT USE A SPA OR HOT TUB.

AVERTISSEMENT: LES PERSONNES ATTEINTES DE MALADIES INFECTIEUSES NE DEVRAIENT PAS UTILISER UNE CUVE DE RELAXATION.

WARNING: TO AVOID INJURY EXERCISE CARE WHEN ENTERING OR EXITING THE SPA OR HOT TUB.

AVERTISSEMENT: POUR ÉVITER DES BLESSURES, USER DE PRUDENCE EN ENTRANT DANS UNE CUVE DE RELAXATION ET EN SORTANT.

WARNING: DO NOT USE DRUGS OR ALCOHOL BEFORE OR DURING THE USE OF A SPA OR HOT TUB TO AVOID UNCONSCIOUSNESS AND POSSIBLE DROWNING.

AVERTISSEMENT: POUR ÉVITER L'ÉVANOUISSEMENT ET LA NOYADE ÉVENTUELLE, NE PRENDE NI DROGUE NI ALCOOL AVANT D'UTILISER UNE CUVE DE RELAXATION NI QUAND ON S'Y TROUVE.

WARNING: PREGNANT OR POSSIBLY PREGNANT WOMEN SHOULD CONSULT A PHYSICIAN BEFORE USING A SPA OR HOT TUB.

AVERTISSEMENT: LES FEMMES ENCEINTES, QUE LEUR GROSSESSE SOIT CONFIRMÉE OU NON, DEVRAIENT CONSULTER UN MÉDECIN AVANT D'UTILISER UNE CUVE DE RELAXATION.

WARNING: WATER TEMPERATURE IN EXCESS OF 38 °C MAY BE INJURIOUS TO YOUR HEALTH.

AVERTISSEMENT: IL PEUT ÊTRE DANGEREUX POUR LA SANTÉ DE SE PLONGER DANS DE L'EAU A PLUS DE 38 °C.

WARNING: BEFORE ENTERING THE SPA OR HOT TUB MEASURE THE WATER TEMPERATURE WITH AN ACCURATE THERMOMETER.

AVERTISSEMENT: AVANT D'UTILISER UNE CUVE DE RELAXATION MESURER LA TEMPÉRATURE DE L'EAU À L'AIDE D'UN THERMOMÈTRE PRÉCIS.

SAFETY INSTRUCTIONS

WARNING: DO NOT USE A SPA OR HOT TUB IMMEDIATELY FOLLOWING STRENUOUS EXERCISE.

AVERTISSEMENT: NE PAS UTILISER UNE CUVE DE RELAXATION IMMÉDIATEMENT APRÈS UN EXERCISE FATIGANT.

WARNING: PROLONGED IMMERSION IN A SPA OR HOT TUB MAY BE INJUROUS TO YOUR HEALTH.

AVERTISSEMENT: L'UTILISATION PROLONGÉE D'UNE CUVE DE RELAXATION PEUT ÊTRE DANGEREUSE POUR LA SANTÉ.

WARNING: DO NOT PERMIT ELECTRIC APPLIANCES (SUCH AS LIGHT, TELEPHONE, RADIO, OR TELEVISION) WITHIN 1.5 M OF THIS SPA OR HOT TUB.

AVERTISSEMENT: NE PAS PLACER D'APPAREIL ÉLECTRIQUE (LUMINAIRE, TÉLÉPHONE, RADIO, TÉLÉVISEUR, ETC) À MOINS DE 1.5 M DE CETTE CUVE DE RELAXATION.

CAUTION: MAINTAIN WATER CHEMISTRY IN ACCORDANCE WITH MANUFACTURER'S INSTRUCTION.

ATTENTION: LA TENEUR DE L'EAU EN MATIÈRES DISSOUTES DOIT ÊTRE CONFORME AUX DIRECTIVES DU FABRICANT.

Hyperthermia occurs when the internal temperature of the body reaches a level several degrees above the normal body temperature of 98.6 °F (37 °C). The symptoms of hyperthermia include drowsiness, lethargy, and an increase in the internal temperature of the body. The effects of hyperthermia include:

- (a) unawareness of impending hazard;
- (b) failure to perceive heat;
- (c) failure to recognize the need to exit spa;
- (d) physical inability to exit spa;
- (e) fetal damage in pregnant women; and
- (f) unconsciousness and danger of drowning.

WARNING: THE USE OF ALCOHOL OR DRUGS CAN GREATLY INCREASE THE RISK OF FATAL HYPERTHERMIA IN HOT TUBS AND SPAS.

AVERTISSEMENT: LA CONSOMMATION D'ALCOOL OU DE DROGUE AUGMENTE CONSIDÉRABLEMENT LES RISQUES D'HYPERTHERMIE MORTELLE DANS UNE CUVE DE RELAXATION.

SAFETY INSTRUCTIONS

For spas relying on a specific means of egress, such means shall not be removed when the spa is in use.

DANGER – This appliance is not intended for use by persons (including children) with reduced physical, sensory or mental capabilities, or lack of experience and knowledge, unless they have been given supervision or instruction concerning use of the appliance by a person responsible for their safety.

Children should be supervised to ensure that they do not play with the appliance.



Safety graphical symbol ISO 20712-1, WSM002 – Keep children under supervision in the aquatic environment

DANGER – Risk of Accidental Drowning (especially children under 5 years). Caution shall be exercised to prevent unauthorized access to the spa by children. This can be reached by an adult supervisor securing the means of access or installing a safety protection device to the spa. To avoid accidents during spa use, ensure that children are kept under constant adult supervision).

Avoid putting the head under water at all times.

Avoid swallowing spa water.

DANGER – No Diving.



Safety graphical symbol ISO 20712-1, WSP005 – No Diving

COMPLIANCE

Relax and rest assured that your Master Spas manufactured spa has been built with safety in mind. We manufacture our self-contained spas to meet a stringent list of industry standards.

Our spas comply with the following industry standards:

- UL 1563 Standard for Electric Spas, Equipment Assemblies and Associated Equipment
- ICC ISPSA International Swimming Pool & Spa Code
- European Standard EN 17125 for Domestic Spas/Whirlpool Spas/Hot Tubs – Safety Requirements and Test Methods
- VGB Virginia Graeme Baker Pool and Spa Safety Act (Certified by UL to UL 1563)
- ANSI/APSP-6 Standard for Portable Spas
- ANSI/APSP/ICC-14 Standard for Portable Spa Energy Efficiency
- CEC Title 20 Appliance Efficiency Regulation
- CSA C22.2 No. 218.1 Spas, Hot Tubs and Associated Equipment
- CE - EN 60335-2-60 Household and Similar Electrical Appliances – Safety: Particular Requirements for Whirlpool Baths and Whirlpool Spas
- CE - EN 60335-1 Household and Similar Electrical Appliances – Safety: General Requirements
- 93/68/EEC CE Marking Directive
- 2014/35/EU Low Voltage Directive
- 2014/30/EU EMC Directive
- AS1926.3-2010 RC2016
- 2014/53/EU Wireless Directive
- UKCA Electromagnetic Compatibility Regulations 2016
- UKCA Electrical Equipment (Safety) Regulations 2016
- UKCA Radio Equipment Regulations 2017
- UKCA The Restriction of the Use of Certain Hazardous Substances in Electrical and Electronic Equipment Regulations 2012
- EU REACH Compliant



VGB SUCTION SAFETY & MAINTENANCE INSTRUCTIONS

VGB 2008:

WARNING



Read and follow all instructions in this manual and on the suction fitting. Failure to follow instructions can cause severe injury and/or death.



Failure to remove pressure test plugs and/or plugs used in winterization of the spa/swim spa from the suction outlets can result in an increased potential for suction entrapment.



Suction outlet components have a finite life. The cover/grate should be inspected frequently and replaced at least every seven years, or if found to be damaged, broken, cracked, missing, or not securely attached.



If the fitting is missing or broken, replace with a fitting of equivalent rating or higher. Use of a lower rated suction fitting could result in entrapment of the body which could result in serious injury including drowning.



Do not use or operate spa/swim spa if this suction fitting is missing, broken or not secured per instructions. The suction fitting is intended to prevent entrapment of the body. Use of the spa/swim spa with a missing, broken or improperly secured suction grate may result in serious personal injury including drowning.



When the spa/swim spa is in operation, suction is created at this fitting. Users of the spa/swim spa must be instructed not to come in contact with this fitting in such a way as to block its orifice. If a user of the spa/swim spa blocks this fitting with his/her body, serious personal injury or drowning may occur.

IMPORTANT SAFETY INSTRUCTIONS



WARNING - SUCTION ENTRAPMENT HAZARD

Suction in suction outlets and/or suction outlet covers which are damaged, broken, cracked, missing, or unsecured can cause severe injury and/or death due to the following entrapment hazards:

Hair Entrapment: Hair can become entangled in suction outlet cover.

Limb Entrapment: A limb inserted into an opening of a suction outlet sump/fitting or suction outlet cover that is damaged, broken, cracked, missing, or not securely attached can result in a mechanical bind or swelling of the limb.

Body Suction Entrapment: A negative pressure applied to a large portion of the body or limbs can result in an entrapment.

Evisceration/Disembowelment Entrapment: A negative pressure applied directly to the intestines through an unprotected suction outlet sump or suction outlet cover which is damaged, broken, cracked, missing, or unsecured can result in evisceration / disembowelment entrapment.

Mechanical Entrapment: There is potential for jewelry, swimsuit, hair decorations, finger, toe, or knuckle to be caught in an opening of a suction outlet cover resulting in mechanical entrapment.

VGB SUCTION SAFETY & MAINTENANCE INSTRUCTIONS

TO REDUCE THE RISK OF ENTRAPMENT HAZARDS:

- Never use a spa/swim spa if any suction outlet component is damaged, broken, cracked, missing, or not securely attached.
- Replace damaged, broken, cracked, missing, or not securely attached suction outlet components immediately.
- It is recommended that suction components be inspected at least monthly.
- Replace the suction within 7 years from the installation date. Contact your dealer or local service center for quoting and scheduling this required maintenance. This is a mandated regulation and is not part of nor covered by the spa/swim spa warranty.

NOTE: Always review entire safety and maintenance information before beginning maintenance. Contact Master Spas for Suction Installation information for complete suction assembly replacement.

GLOSSARY OF SPA TERMINOLOGY

Your new spa features a variety of jets. All jets, regardless of style, return the water to the spa. Air is mixed with the water by using the air controls (if equipped) creating a vigorous massage. Water flow is adjusted by simply turning the outer face of most jets. Your spa may have a combination of pulsating, rotating, dual pulsating and directional adjustable jets. Here are some terms and definitions to help get you acquainted with your spa.

1. THERAPY JETS

Located throughout the seats of the spa to offer a variety of therapy combinations.

2. NECK AND SHOULDER JETS (if equipped)

Located above the normal water level to provide massaging action to the back of the neck and shoulders.

3. MASTER BLASTER® FOOT THERAPY JET (if equipped)

Large jet with several fixed nozzles located in the bottom of the spa near the floor to provide excellent massage to the feet.

4. JET DIVERter VALVE* (if equipped)

Located on the top flange of the spa, this large valve physically diverts the flow of water from one group of jets to another. Be sure that no sand or particles are brought into the spa as they will cause the diverter to seize up. It is best to turn the diverter valve only when the pump is turned off.

5. 3-WAY DIVERter JET* (if equipped, Getaway Hot Tubs)

This large jet can be turned 180° to 3 different points and diverts the flow of water from one group of jets to another. With the pump turned off, twist the face of this jet 1/4 turn at a time clockwise or counterclockwise to adjust.



6. WATER FEATURE VALVE* (if equipped)

Located on the top flange of the spa, this smaller valve adjusts water flow to the waterfalls and/or water features in your spa.

NOTE: When the spa is not in use, this valve should be turned mostly shut (not completely shut) to prevent the water features from allowing water to hit the cover while it is closed. If left mostly open, water may hit the cover and possibly run out of the spa causing water loss.

7. AIR CONTROL VALVE*

These smaller valves are located around the top of your spa. You may increase or decrease the force of your jets by opening or closing the air control valves. Each air control valve will typically function 1 to 2 groups or seats of jets in the spa. When not in use the air controls should be kept in the closed position as the air being introduced into the water can tend to cool the water and increase the dissipation rate of sanitizer levels.

***NOTE:** See Pump Diagrams in the back of this manual for location of valves, controls, and jets.

8. TOPSIDE CONTROL PANEL

You may safely control spa functions from inside or outside your spa using the Topside Control Panel. This panel is used to control the water temperature, pumps, the spa light, automatic filtration cycles and other advanced functions. The digital display will give you a constant temperature readout and will notify you in case of certain malfunctions. Several user programmable functions are also available.

GLOSSARY OF SPA TERMINOLOGY

9. PERSONAL REMOTE CONTROL/AUXILIARY BUTTON* (if equipped)

Select spa models may have an additional remote which allows the user to control the jet therapy while remaining in the seat (if applicable). By pressing the control one time, you will activate the associated pump.

10. ACCESS PANELS

These are the skirt panels located around all four sides of the spa. All of the skirt panels are removable should service be required. Master Spas recommends at least 3 feet of access be provided around the spa.

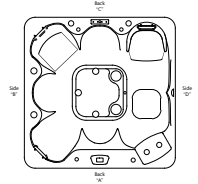

11. EQUIPMENT ACCESS PANEL

This is the "Front" or "A" side skirt access panel, typically the same side as the Topside Control Panel. This area typically houses the majority of components responsible for the spas operation. These components include the pumps, heater, spa control system, ozonator (if equipped), and LED light system (if equipped). Pump and equipment placement may vary by model.

12. FILTER LID

This lid fits over the filter area and weir gate to cover the filters. Remove filter lid to access filters for maintenance. For models equipped with a telescoping filter housing, simply lift up to remove this floating assembly to access the filter. At low speed water flow or when the filtering/heating pump is off, the telescoping part of the filter assembly will float at or near the waterline. At high speed water flow, it will be drawn downward. See Accessing Filters in the Regular Maintenance Procedures section for detailed instructions on filter assemblies.

13. WEIR GATE

The weir gate is the horizontal door located in front of the filters that helps keep debris trapped in the filter area.

14. SPA CONTROL SYSTEM

This houses the wiring and electrical components necessary to operate the spa.

15. SPA HEATER

This is an electric heater housed in a stainless steel tube. It is thermostatically controlled and equipped with high-limit temperature safety shut-off sensors.

***NOTE:** See Pump Diagrams in the back of this manual for location of valves, controls, and jets.

16. SLICE VALVES

These valves are used by service personnel to shut off water to the heating system (heater and pump plumbed to the heater) so that the spa water does not need to be drained if the spa requires service to the heating system (varies by model).

NOTE: Slice valves must be completely open during normal operations.

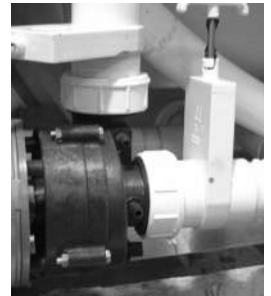

Slice Valve and Pump Union

GLOSSARY OF SPA TERMINOLOGY

17. PUMP UNION

This connects the plumbing and pump together. These are used to help relieve possible pump air locks or for service personnel to easily service the pumps.

18. HEATER UNION

These are used by service personnel to easily service the heater.

19. MAIN THERAPY PUMP

This produces water flow through the main jets in the spa. The first pump may be operated on two speeds (varies by model). Low speed (if applicable) will produce efficient water circulation during filtration, heating of the spa water, and gentle jet action. High speed provides maximum jet action. The main pump is controlled by the “Jets” or “Jets 1” button on the Topside Control Panel.

20. SECONDARY THERAPY PUMP (if equipped)

This produces water flow through 1 to 2 groups or seats of jets in the spa. The second pump operates similar to the main pump and is controlled by the “Jets 2” or “Aux” button on the Topside Control Panel.

21. THIRD THERAPY PUMP (if equipped)

This produces water flow through 1 to 2 groups or seats of jets in the spa. This is controlled by the “Jets 3” button on the Topside Control Panel.

22. CIRCULATION PUMP (if equipped)

This dedicated, smaller, energy efficient pump provides water flow for filtration and heating, instead of utilizing the high powered main therapy pump..

ECOPUR® CHARGE

MASTER CORE TECHNOLOGY

The EcoPur® Charge* is made from Master Spa's patented filtration fabric. This fabric is wound tightly into a nautilus master core, creating a catalytic cell. The nautilus fabric cell is encased by a unique "spring core" that allows for maximum flow and water "charging". As water comes in contact with the EcoPur® Charge Master Core, a chemical reaction causes zinc and copper hydroxides to form in controlled amounts. Like Mother Nature, when controlled releases of copper and zinc oxides are carried into the filtered water, they kill bacteria and provide hostile conditions for algae and fungal growth. Using EcoPur® Charge helps reduce the amount of chemicals needed, therefore safeguarding the hot tub's plumbing and equipment because pipes are protected against the corrosive effects of chlorine. EcoPur® Charge Master Core Technology is another exclusive design by Master Spas.

FEATURES

- Releases Sanitizing Copper & Zinc Oxides
- Reduces Water Soluble Heavy Metals
- Controls Scale, Bacteria and Algae
- Safeguards the Spa's Plumbing
- Reduces Use of Chemicals
- Helps Prevent Damage to Swimwear



*PATENTS PENDING

THE ADVANTAGES OF ECOPUR® CHARGE

ECOPUR® CHARGE INSTALLATION

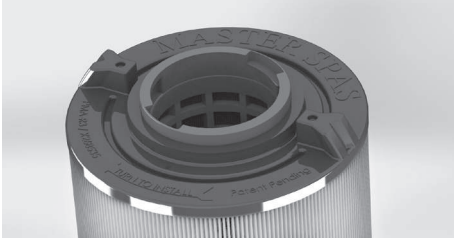

Master Spas Outer Filter*



EcoPur® Charge*

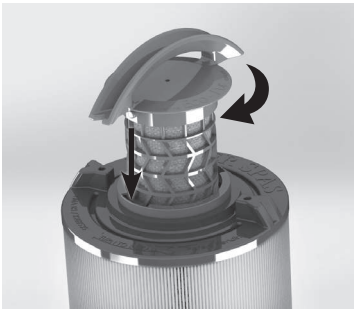

Turn Clockwise to Lock

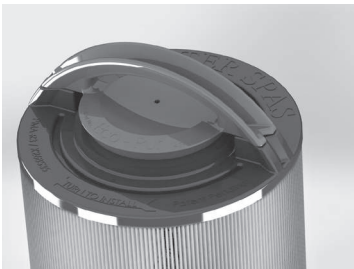

STEPS FOR INSTALLATION

1. Insert EcoPur® Charge into outer filter.
2. Twist EcoPur® Charge clockwise to lock in place while holding on to outer filter. When snapped in to locked position, EcoPur® Charge handle aligns with molded points on outer filter.

NOTE: EcoPur® Charge should be replaced every 6 months. Initial snap in fit of inner EcoPur® Charge to outer filter may be tight, especially if both are new.



*PATENTS PENDING

Before jumping into Water Maintenance, here are some terms to help you.

1. **PARTS PER MILLION (PPM):** This is a form of measurement used in most pool or spa chemical readings. Best described as any one million like items of equal size and make up, next to one unlike item, but of equal size. This would be one part per million.
2. **TOTAL ALKALINITY (TA):** Measures substances in your water such as hydroxides, carbonates and bicarbonates. When at the proper levels, these elements keep your water from clouding and growing bacteria, as well as prevent the inner workings of your hot tub from deteriorating or forming scale. TA also helps to stabilize pH. The higher the TA level (as long as it is within the recommended range), the less likely the pH is to change. With low alkalinity, the pH will fluctuate and be harder to control. With high alkalinity, it becomes extremely difficult to change the pH.
3. **PH OR POTENTIAL HYDROGEN:** This indicates the acidity or basicity of the water. The goal is to have a neutral, stable pH to prevent spa damage and unhealthy conditions. Low pH levels can corrode metals, etch or stain fiberglass or acrylic, cause unsanitary conditions that irritate the eyes or skin and destruct the total alkalinity of the water. High pH can cause cloudy water, eye or skin irritation, scale formation and poor chlorine or bromine efficiency. Note that the chemicals you are using to sanitize and clean your hot tub can also lower or raise the pH level in the water. Unfortunately, there are many variables to preventing high pH in your hot tub.
4. **SHOCKING:** By shocking the water in your hot tub, you remove organic compounds from the water, kill bacteria, remove bromamines or chloramines and reactivate the bromides in the spa for cleaner water. When reactivating Bromides in the water, this is essentially reactivating the inert sanitizer in your hot tub when it is available to do so. Oxidizer/non-chlorine shock acts by releasing oxygen in the water, which serves a similar function as chlorine. An advantage to using this type of shock is that the water is safe to enter after 15 minutes of the application and excessive sanitizer (chlorine) levels do not occur. However, an oxidizer/non-chlorine shock doesn't disinfect the water for bacteria. If you use chlorine to shock, you must wait until the total chlorine reading is at a level safe to reenter the water.
5. **SEQUESTERING:** This can be defined as the ability to form a chemical complex which remains in a solution, despite the presence of a precipitating agent (i.e. calcium and metals). This helps control the minerals and metals in the water to help with water quality. If the minerals and metals in water are not sequestered, they can cause a reaction, turning the water brown, red, orange or green depending on the minerals and metals present in your water. It is important to add a sequestering agent when adding water to your spa and even on a regular basis (if bottle instructions recommend doing so). Common names for sequestering chemicals are: minquest, stain and scale control, metal-x, spa defender, spa metal gone, etc.
6. **FILTRATION:** Filters are necessary to remove particles of dust, dirt, algae, etc., that are continuously entering the water. If the spa is not operated long enough each day for the filter to do a proper job, it puts a greater burden on the chemicals, causing extra expense. Filtration time will depend on the water capacity, pump and filter size and, of course, bather load. Spare filter cartridges should be kept on hand to make it easy to frequently clean the cartridge without the need for a long shut down. This will also allow the cartridge to dry out between usages, which may increase the cartridge life span. Replace the cartridge when either cleaning no longer improves filtration or the pleats begin to deteriorate. Cartridge cleaning should be done a minimum of once a month. More often with a heavy bather load. See Cleaning Your Filter Elements in the Regular Maintenance section.
7. **SANITIZERS:** Germs and bacteria enter the water from the environment and the human body; a sanitizer keeps the water balanced and safe to use. Either chlorine or bromine can be used as a sanitizer to create a healthy water environment.

WATER CHEMISTRY TERMS YOU SHOULD KNOW

A. Chlorine:

1. Only one type is approved for spa use. Sodium dichlor which is granular, fast dissolving and pH neutral chlorine.
2. Chlorine is an immediate sanitizer and will be added as needed to maintain free chlorine levels.

B. Master Clear Salt System

1. This system uses electrolysis to break down salt to produce hypochlorous which will sanitize the spa and is read like chlorine on a test strip or liquid test kit.
2. The Master Clear Salt System requires its own set of specifications for water maintenance and care. See the section on the Master Clear Salt System for more details and instructions.

WARNING: Do not use other salts systems. Only the Master Clear Salt System is approved for use on the Master Spas hot tubs. Other systems will result in unwarranted wear or damage to the spa components.

C. Bromine

1. Two types of tablets:
 - a. Hydrotech
 - b. Lonza
2. Bromine is a slow dissolve chemical and may take a few days to develop a reserve or reading in the water.

NOTE: Bromine use is not recommended with EcoPur® filters as it can hinder being able to maintain proper reserve/residual levels for maintaining sanitary conditions.

WARNING: Nonslip, Comfort Floor System mats are not compatible with bromine and will result in unwarranted deterioration of the material. Do not use bromine if your spa is equipped with these mats.

8. **TOTAL DISSOLVED SOLIDS (TDS):** Materials that have been dissolved by the water, i.e. like what happens when you put sugar in coffee or tea.
9. **USEFUL LIFE OF WATER (IN DAYS):** Water should be drained at least once every 180 days. Useful life may vary by usage and bather load.
10. **DEFOAMER:** A chemical used to temporarily reduce foaming. Causes of foaming include body oils, cosmetics, lotions, surface cleaners, high pH or algae, as well as other organic materials. Low levels of calcium or sanitizer can also cause increased foaming. Note that you may need to physically remove the foam and/or drain all or part your water to remove or dilute the causes of the foam.
11. **CALCIUM HARDNESS:** This measurement tells you how much magnesium and calcium are in your water. However, calcium hardness can react with all of the chemicals, bacteria, dirt and other substances that your water dissolves and get thrown out of balance. Just like the other elements, calcium levels must remain balanced and need to be monitored or you run the risk of metal deterioration, water foaming or clouding and scale formation at the surface of your water.
12. **BIOFILM:** This is any group of microorganisms in which cells stick to each other and often these cells adhere to a surface (ie. spa plumbing and shell). Biofilm can occur over time during the use of your spa.
13. **OFF GAS:** Some chemicals will release gases as they activate in the water. The most active point is typically right after being added to the water. These gases can be corrosive and are something to consider when maintaining the spa. It is ideal to leave the cover off for approximately 15 minutes after adding chemicals, to help reduce the concentration of off gas under the cover which can cause accelerated wear and tear or unwarranted damages.

NOTE: Always leave spa cover open for at least 15 minutes after adding chemicals to prevent the off gas from damaging your spa cover, spa pillows, stainless steel hardware and other critical parts.

WHY ARE CHEMICALS IMPORTANT IN A SPA

1. EVAPORATION:

As water evaporates, only pure water evaporates, leaving the salts, minerals, metals, and any unused chemicals behind. Adding water adds more salts, minerals, and metals. In time, the water can become saturated with these dissolved solids and can cause stains or scale to form on the walls of the spa or a scale build up inside the equipment. Colored or cloudy water and possible corrosion of plumbing and fittings may also occur.

2. HEAT:

Heat causes much quicker evaporation and also will cause minerals and metals to precipitate out of solution.

3. AIR:

Dust and other airborne contaminants are introduced into the spa.

4. ENVIRONMENT:

The environment surrounding the spa can also impact the water quality. Items such as pollen, grass, sand, dirt, lawn fertilizer, airborne dust, insects, leaves, and pets can all affect the water quality of the spa.

5. BATHERS:

As the spa is used, bathers introduce contaminants to the water. Increased bather load, length of use and frequency will increase the amounts of contaminants added in to the water.

NOTE: The maintenance routines set forth in this manual may need to be adjusted depending on bather load and how much the spa is being used.

WATER MAINTENANCE – RECOMMENDED RANGES

WATER CHEMISTRY GUIDE

Before treating your water, refer to the Model Specifications section of this manual for the correct gallons of your spa, to ensure you are adding the correct amount of chemicals. The concentration of active ingredients in spa chemicals varies by manufacturer, so always consult chemical manufacturer's instructions. When adding spa chemicals, always spread them across the surface of the water while the pumps are running. See chart below for recommended ranges.

PARAMETER	VALUE ^a
Water Clarity	Clear view of the bottom
Color of Water	No color should be observed ^b
Total Alkalinity (TA)	80 - 150 ppm
pH Value ^{c, d}	7.2 - 7.6
*pH Value (Master Clear Salt System) ^{c, d}	7.0 - 7.2
Chlorine	2 - 4 ppm
Bromine (in mg/l)	3 - 5 ppm
Calcium Hardness	180- 250 ppm
When using alternative/additional disinfectants other appropriate parameters may be considered.	
^a Consult national regulations and guidelines for any deviations.	
^b Natural water sources may introduce water coloration.	
^c Subject to the flocculant(s) used (if any).	
^d When pH is greater than 7.5 the free active chlorine is less than 50 %.	

NOTE: Recommended levels stated in this manual are based on industry standards for permanently installed and portable residential spas. Improper use of chemicals may result in unsanitary and unsafe water conditions as well as unwarranted discoloration, degradation, damage and other imperfections of the spa surface and components.

*Ideal pH level for Master Clear Salt System hypochlorous generation and effectiveness. Maintain pH in this range when Master Clear Salt System is in use..

 **WATCH HOW-TO VIDEOS:** masterspas.com/video-tutorials

NOTE: If your spa is equipped with the Master Clear Salt System upgrade, proceed to page 72 for alternate details and start up information.

START UP STEPS

1. Your spa should be filled with fresh tap water using a Pre-filter, which can be obtained from your local Master Spas dealer. This Pre-filter will help remove many of the minerals existing in the water, which will make adjusting the water balance easier after a new fill. Never use more than 50% softened water when filling the spa.
2. During the initial filling of the spa, add a sequestering agent to combat suspended minerals in the water. The agents are sold under many different names such as Mineral Clear or Metal Protect. Always follow the instructions listed on the bottle and allow water to circulate and filter for at least 30 minutes (or per bottle recommendations) before adding any other chemicals.
3. Test water for pH, total Alkalinity, and Calcium hardness. There are two different methods you can use to test your water.

TEST STRIPS: The pads on these thin strips react by changing colors when you dip them in the hot tub water. To avoid faulty test results, use care when removing a testing strip from the packaging. Open the package and shake one strip out into your hand, avoiding contact if possible with the remaining strips. Seal the container immediately so the remaining strips are not exposed to moisture. Dip the test strip into the water and follow the instructions supplied with test strips as instructions may vary. Note the colors on your testing strip and compare these to the key found on the packaging to determine whether elements are neutral, too high or too low.

TESTING KIT: When using a testing kit, you will be examining an actual water sample from your hot tub, rather than a strip. Be careful to follow the instructions on your kit, filling the container to the appropriate level and then dropping the instructed liquid into the container. Compare the new color of your water to the key provided with the kit to determine how to proceed. Depending on which kit you purchase, it can test for each one of these elements: total alkalinity, pH, chlorine, bromine and calcium hardness.

4. Adjust pH and total Alkalinity (TA) utilizing the directions on the chemical bottles. Wait 15 minutes, test and adjust if necessary.
5. It may be necessary to retest and add additional chemicals to get to the proper levels.
6. Add concentrated chlorinating granules (sodium Dichlor-s-triazinetreone) on initial start up to begin sanitizing the spa water, according to directions on the chemical bottle. Bathers should not enter the spa until the chlorine drops to a safe level, refer to the Water Chemistry Guide in this section. It is important not to add the chlorinating granules until the pH, alkalinity and calcium hardness have been adjusted to their proper levels.

NOTE: See the Model Specifications section of this manual for the correct gallons of your spa, to ensure you are adding the correct amount of chemicals. When adding chlorine or non-chlorine shock/oxidizer always spread it across the water while the pumps are running. The concentration of active ingredients in spa chemicals varies by manufacturer.



WATCH HOW-TO VIDEOS:
masterspas.com/video-tutorials

▶ WATCH HOW-TO VIDEOS: masterspas.com/video-tutorials

BEFORE EACH USE

Test the spa water for proper pH and sanitation levels. Adjust accordingly to the proper levels outlined in the Water Chemistry Guide, found in the Water Maintenance – Recommended Ranges section. Appropriate levels should be present before use of the spa. Bathers should not enter the spa if the chlorine levels are outside of the safe, recommended ranges.

AFTER EACH USE

Test water and treat accordingly to maintain proper pH and free chlorine levels for continued sanitary conditions after use. The amount of people using the spa (and duration of use) will deplete chlorine levels and can cause free chlorine to test below total chlorine, resulting in a more frequent need to use an oxidizer/non-chlorine shock treatment.

3 TIMES A WEEK

Test the water using chemical test strips. Adjust sanitizer, pH and Alkalinity accordingly, following directions on the chemical manufacturer's bottle. If free chlorine level measures less than total chlorine level, additional non-chlorine shock/oxidizer treatment is necessary.

ONCE A MONTH

Soak your regular filter elements overnight in a container with spa Filter Cleaner and then rinse with clean water. For best results, allow the filter to dry before re-inserting. (The EcoPur® element should never be cleaned in a filter cleaner. Just rinse with water.) When cleaning filters, be sure to never have the pumps (including the circulation pump) running without the filters in place. Failure to do so may result in debris being drawn into the pumps causing unwarranted damage. See Cleaning Your Filter Elements in the Maintenance section of this manual for more information.

EVERY 180 DAYS

Drain and refill your spa with fresh water, install a new EcoPur® element, clean the regular filter, and repeat start up procedure. The regular filter should be replaced at least once every year. Over time and bather use, biofilm buildup can occur. Chemical products are available to help remove biofilm and should be used periodically before draining.

AS NEEDED

If the water looks hazy, make sure pH is in the proper range and treat with chlorinating granules to maintain free chlorine levels. Treat with non-chlorine shock (oxidizer shock) if free chlorine is less than total chlorine. Always refer to the chemical manufacturer's dosage recommendations listed on the container. Free chlorine levels should be maintained per the Water Chemistry Guide.

A defoamer may be used when excessive foaming occurs. Over use of a defoamer will result in cloudy, milky water. These are general recommendations for water maintenance that may vary by usage and bather load. Depending on bather load and frequency of use, drain and refill times may vary as well as the frequency of cleaning your filters.

USE ONLY SPA CHEMICALS

Do not use chemicals designed for use in swimming pools. With a spa you are working with a small volume of hot water compared to a large volume of relatively cool water in a swimming pool. Because of this, chemicals will have a shorted life span and bacteria can grow more quickly than in a swimming pool. A spa is less forgiving than a pool and requires that whatever is put into it have a pH as close to neutral as possible. That is why only chemicals made for spas should be used. Always refer to the chemical manufacturer's dosage recommendations listed on the container.

WATER MAINTENANCE – TROUBLESHOOTING GUIDE

EN 17125

▶ WATCH HOW-TO VIDEOS: masterspas.com/video-tutorials

PROBLEM	POSSIBLE CAUSES	HOW TO FIX IT
CHLORINE ODOR	Excessive chlorine	Shock water with oxidizer/non-chlorine shock treatment
	Low pH	Adjust pH if necessary
WATER ODOR	Low levels of sanitizer	Adjust sanitizer level with chlorinating granules
	pH out of range	Adjust pH if necessary
	Bacteria or algae growth	If sanitizer has already been adjusted, it may be necessary to perform a system flush
CLOUDY WATER	Dirty filters or inadequate filtration	Clean filters with filter cleaner and adjust filtration
	Unbalanced water chemistry	Test and adjust chemistry levels
	Old water	Drain, clean inner shell and refill with filtered water
CLOUDY AND GREEN WATER	Total alkalinity levels are low	Use a pH increaser
	Sanitizer levels are low	Apply oxidizer/non-chlorine shock treatment and adjust sanitizer
CLEAR GREEN WATER	High iron or copper content	Use a sequestering agent
	Sanitizer levels are low	Apply oxidizer/non-chlorine shock treatment
BROWN WATER	High iron or manganese level	Use a sequestering agent
FOAMING	High levels of body oils, lotions, soap, etc.	Add small amount of defoamer, an enzyme product and check water chemistry
	Low calcium hardness	Use a calcium hardness increaser
	Unbalanced water chemistry	Test and adjust chemistry levels
EYE OR SKIN IRRITATION	Unsanitary water	Adjust water chemistry according to testing results
	Total chlorine level above 5 ppm	Apply oxidizer/non-chlorine shock treatment
	Poor sanitizer/pH levels	Adjust pH level as necessary
SCUM DEPOSITS AT WATERLINE	Body oils and dirt	Use multi-purpose cleaner to clean spa surface and add enzyme product to spa water
CHALKY, WHITE SCALE DEPOSITS	Minerals present in the water and lack of sequestering agent use	When tub is drained, use a multi-purpose cleaner or white vinegar and scrub with a soft cloth
PITTING OF METAL FIXTURES	Low pH or total alkalinity	Check water chemistry and adjust

NOTE: Please refer to the Water Maintenance - Recommended Ranges section to review recommended chemical levels.

REGULAR MAINTENANCE PROCEDURES

▶ WATCH HOW-TO VIDEOS: masterspas.com/video-tutorials

EN 17125

NOTE: These maintenance procedures are the responsibility of the spa owner to perform. These procedures are not covered by the spa warranty.

DRAINING YOUR SPA

Before you start draining your spa, be sure all power is turned off to it. Your spa requires periodic draining and cleaning to ensure a safe, healthy environment. It is recommended that you clean your spa at least every 180 days or as necessary. Heavy bather load will require draining and cleaning it more often. Draining times will vary by model when using the equipped internal drain assembly. A sump pump may also be used to expedite the draining of the spa.

NOTE: If your hot tub required multiple electrical services, be sure to turn off breakers for all services powering the spa equipment. See model specifications and appropriate electrical requirements for your model or contact your electrician if you are not familiar with how your electrical was installed. A breaker or power cut off should always be within line of sight.

Caution and careful planning should be taken if draining in freezing temperatures to ensure the process is performed quickly (by use of a submersible pump) and that the water is either refilled quickly again or winterization steps are immediately performed. Try to plan your normal draining maintenance during times when temperatures are above freezing. Excess water in the plumbing can freeze in a short time frame depending on temperatures and conditions. Water freezing within plumbing and components can result in freeze damage which is not warranted.

STEPS FOR USING THE EQUIPPED INTERNAL DRAIN

The spas are equipped with a drain assembly which can be located on the front side of the spa behind the skirt (same side as the topside control panel or where most of the spa equipment is located). The drain will be located in the equipment area behind the front skirt panel (Figure 1).



Figure 1



Figure 1.1

1. Remove the front skirt panel by removing its panel screws. The drain will be located inside the equipment bay (see Figure 1 & Figure 1.1).
2. To start the flow of water with this drain assembly; remove the cap, twist the face counterclockwise and pull out slightly on the face. A garden hose can be attached to the end of the drain assembly, if so desired.

NOTE: With the cap removed from the drain; water may drip or weep from the drain. This is normal. Be sure that the steps are followed in reverse order when draining is finished. Make sure that the drain cap is reattached and the valve is put back to the fully closed position so that there is no water leaking from the drain assembly.

STEPS FOR USING A SUMP PUMP*

1. Carefully lower submersible pump with hose connected into the bottom of spa, taking care not scratch or gouge your spa shell.
2. Run the discharge end of the hose from your submersible pump to a desired location several feet away from your spa, where the water will drain away from foundation that the spa is resting on.
3. Plug in/turn on your submersible pump.

REGULAR MAINTENANCE PROCEDURES

▶ WATCH HOW-TO VIDEOS: masterspas.com/video-tutorials

NOTE: These maintenance procedures are the responsibility of the spa owner to perform. These procedures are not covered by the spa warranty.

4. Turn off/ disconnect your submersible pump once it is no longer able to suck up any further water (indicated by a suctioning sound and water no longer coming out of the drainage hose). If you plan to fully wipe down and clean your entire spa shell, a shop vac can be used to remove the remaining small pockets of water in the spa.

*Sump Pump is not provided with spa.

SPA SURFACE CARE

- During use, always remove debris and pollutants that have settled in the water or built up on the spa surfaces as it occurs. These pollutants can cause growth of bacteria, algae, fungus or biofilm if left on the spa surface and potentially cause stains.
- Clean the spa shell, jets and other controls with a soft cloth and spa shell cleaner to help remove residue and buildup on the shell surface. For any remaining buildup, white vinegar or mild scale remover product may be necessary. Apply to the spa shell and wipe down with a soft cloth. Consult with your local Master Spas dealer for proper spa cleaning products.
- Rinse the cleaned surfaces with fresh water from your garden hose and wipe with a soft cloth as doing so will help to remove residual cleaning agents (as some may cause foaming to occur in the water once spa is refilled).
- Always use an approved insulating spa cover by Master Spas to cover your spa when not in use, especially in outdoor installations where the spa is exposed to weather conditions and sun. Constant, prolonged exposure and use of unapproved or non-insulating spa cover can result in damage to spa surface which would not be warranted.

CARE OF YOUR SPA PILLOWS

- Your spa pillows should be rinsed periodically to remove chemical residue. This helps improve pillow lifespan and slows down deterioration of the pillows (i.e. discoloring, becoming stiff and flaking of the material).
- If the spa will not be used for a period of time, the pillows could be removed and rinsed to prolong their life.

NOTE: Do not cover the spa for 15 minutes after adding chemicals as the off gas can cause damage.

CARE OF YOUR SPA CABINET

The spa cabinet is made from a UV resistant material. The cabinet requires only periodic cleaning with a stream of water from a garden hose. If necessary, use mild soap and water with soft cloth to wipe down cabinet surface. Rinse thoroughly.

REGULAR MAINTENANCE PROCEDURES

ACCESSING FILTERS

Filter Weir with Top Access



Remove Filter Lid



Turn Filters Counter-clockwise to Remove

NOTE: EcoPur filter set is normally placed in filter port closest to the topside control panel, this is ideal when Mast3rPur circulation system present.

Vane Teleweir Filter Housing



Pull Up to Remove Floater Assembly



Turn Filters Counter-clockwise to Remove

Telescoping Filter Housing



Twist Lock Ring Counter-clockwise to Remove Floater



Remove Basket



Turn Filters Counter-clockwise to Remove

Filter Weir with Slide Off Access



Slide Faceplate Up to Remove



Turn Filters Counter-clockwise to Remove

REGULAR MAINTENANCE PROCEDURES

▶ WATCH HOW-TO VIDEOS: masterspas.com/video-tutorials

NOTE: These maintenance procedures are the responsibility of the spa owner to perform. These procedures are not covered by the spa warranty.

Vane Skimmer Filter Housing



Remove Top Cap by Gently Lifting



Lift Up and Remove Basket



Turn Filters Counter-clockwise to Remove

CLEANING YOUR FILTER ELEMENTS

The filter elements are one of the most important components of your spa. Not only are they essential for clean water; they also extend the life of the spa equipment and help avoid unnecessary water changes and re-heating. Your filter elements should be cleaned on a regular basis, at least once a month on average with normal usage. With heavy use, poor water quality and/or high dissolved solid content in water; the filters may need to be cleaned more often. It is recommended to allow filter elements to fully dry after cleaning. For this reason, it is ideal to have a spare set of filters on hand for filter cleaning intervals.

1. Turn off the spa before servicing filters. Never leave to the spa running when removing the filters. Debris can be pulled into the plumbing system and cause unwarranted damage.
2. Remove filter element(s).
3. With a garden hose, spray each element under pressure. Monthly, the standard filter elements should be soaked in a filter cleaner. Do not soak EcoPur® element in a filter cleaner. The EcoPur® element should only be rinsed with fresh, clean water if necessary. Check with your Master Spas dealer for details on cleaning and/or filter replacement recommendations.
4. The EcoPur® element should be replaced every 6 months. The standard filter should be cleaned regularly and will typically last approximately 1 year. Bather load, usage and water quality will effect the longevity of the filters and require more frequent cleaning or replacement.



CLEANING JETS

The majority of jets in your spa can individually be turned on/off. If any of these jets become hard to turn, it will be necessary to remove the jet to clean it as grit/sand and mineral deposits may be present. The jets in your spa can be removed for cleaning by turning them counter-clockwise until they release and then pulling out the jet.

TO CLEAN JETS: Place the jet(s) in a container, fully immerse in white vinegar. Let the jet(s) soak overnight and then rinse with water. Reinstall the jet(s). It may be necessary to clean grit and deposits from the white jet body (mounted in the spa shell) by using a small bristled brush.

REGULAR MAINTENANCE PROCEDURES

NOTE: These maintenance procedures are the responsibility of the spa owner to perform. These procedures are not covered by the spa warranty.

CARE OF LAMINAR FLOW JETS:

In order to keep your Laminar Flow Jets operating properly, follow these steps:

1. Turn off Laminar Flow Jets.
2. Remove outer ring by turning face counter-clockwise while pulling on it.



3. Either the whole Laminar Flow Jet Assembly pops out: Rinse it out and inspect it. Or, if only the outer ring comes off: Remove internal Jet insert with a pair of needle nose pliers and inspect it.
4. Clean plastic diffuser at the back of the Jet insert or Laminar Flow Jet Assembly so all holes are free of debris.



OR



5. Reinstall Jet insert or assembly and outer ring by pushing it in and turning it clockwise until it stops.

NOTE: To prevent premature failure of your spa cover and the possibility of water running out of the spa off the bottom of the cover, always turn Laminar Flow Jets down so that they do not hit the cover when the cover is closed. You do not want to completely turn jets off. Doing so may cause a build up of stagnant water in the water line if not used often.



EN 17125, Do not put finger in massage jet

REGULAR MAINTENANCE PROCEDURES

NOTE: These maintenance procedures are the responsibility of the spa owner to perform. These procedures are not covered by the spa warranty.

CLEANING DIVERTER VALVES

Mineral deposits, grit and sand may get into the internal parts of the diverter valves over time. The diverter valves may become difficult to turn or not turn at all.

CAUTION – TURN OFF SPA BEFORE PROCEEDING WITH THIS MAINTENANCE.



FOR THESE STYLES OF HANDLES, FOLLOW THE STEPS BELOW:

1. Remove the handle from the top of diverter valve by grasping the handle and pulling up with a rocking motion.
2. Turn the cap piece counter-clockwise. It may be necessary to put a clean towel over the cap and turn it with a wrench.
3. Once loose, the cap, internal rotor assembly and handle can be pulled up out of the white plumbing fitting.
4. Wipe down the internal rotor assembly that attaches to the cap and handle.
5. Soak the internal rotor assembly in white vinegar.
6. The inner wall of the white plumbing fitting should also be wiped down. If the surface of the white plumbing has become too abrasive, you can take wet, fine sandpaper and smooth it out.
7. Rinse the diverter internals. Inspect O-rings for cracking or swelling and apply silicone lubricant to them. Then reassemble.

REGULAR MAINTENANCE PROCEDURES

▶ WATCH HOW-TO VIDEOS: masterspas.com/video-tutorials

NOTE: These maintenance procedures are the responsibility of the spa owner to perform. These procedures are not covered by the spa warranty.

CARE OF YOUR SPA COVER

Always cover your spa when not in use with an approved insulating spa cover by Master Spas. Keep the spa cover on to minimize heat loss during heating of the spa between uses (but not while it is being used). This will greatly reduce energy consumption and will cause spa water to heat more rapidly. Water loss and chemical usage will also be reduced.

- Ensure the cover is fitted tightly, as per manufacturer's instructions to maximize insulation.
- Be sure to lock down all straps on the cover after each use.
- Do not allow spa to sit uncovered in direct sunlight. The heat and UV from direct sun exposure can cause damage to exposed shell surfaces of the spa as well as damage or discoloration of the spa controls and fittings.
- See cover manual instructions for detailed instructions on proper cover care. Clean the cover at least once a month using mild soap and water. Rinse thoroughly with fresh water to remove pollutants and soap residue. If mold/mildew staining has occurred (particularly on bottom of the cover), a mixture of bleach and water used with a soft cloth may be necessary. Thoroughly rinse with fresh water after cleaning.
- Keep cover open for 15 minutes after adding chemicals to prevent excessive off gas buildup and damage.
- When the spa is being used, the cover should be placed in a clean, dry area, otherwise it can pick up dirt and bacteria. Covers should not be put on wooden tables or wooden decking because of the risk of bleaching the wood.
- The use of a cover lift accessory or other device ensures the cover will not come into contact with the ground and retains its cleanliness (particularly the surface in close proximity to the spa water surface). The cover should be stored in an appropriate location, where it cannot be damaged, or cause damage.

NOTE: If your spa is going to be left empty for prolonged periods, do not place cover directly on the spa's surface (closed and sealed). Instead, place a 1" block of high density foam between the cover and the spa. This allows for ventilation to help reduce mold and mildew from occurring while the spa is empty.

NOTE: The cover warranty is not part of the limited warranty provided with the spa. It is provided through the cover manufacturer and may not be through Master Spas. Check the tags and labeling on your cover to verify manufacturer and refer to the manufacturer's care, maintenance and warranty information. Your dealer can help provide you with these details.

NOTE: Always use the water feature diverter to turn down the water flow so that the water features do not hit the cover when the cover is closed. Do not turn them all the way off.

CARE OF YOUR OZONE SYSTEM

The ozone hose and check valve connecting between the ozone generator and ozone injector should be inspected and/or replaced, if necessary, every 12 months. Depending on conditions of the air which is being brought in to the ozone generator, the ozone hose and check valve can wear more rapidly. This regular maintenance is not covered under the spa warranty. We recommend that your Master Spas Dealer or service organization be contacted to perform this type of maintenance.

REGULAR MAINTENANCE PROCEDURES

▶ WATCH HOW-TO VIDEOS: masterspas.com/video-tutorials

NOTE: These maintenance procedures are the responsibility of the spa owner to perform. These procedures are not covered by the spa warranty.

CARE OF STAINLESS STEEL

Master Spas uses stainless steel in a number of our spas. Its lasting beauty and resistance to corrosion make it an excellent material for handrails and jets faces. With the proper care it will keep its luster for many years. All stainless steel can corrode given the right circumstances so we have provided a guide to help you keep the stainless components in your spa looking nice. Stainless steel derives its ability to resist corrosion by forming a very thin transparent coating on the surface when exposed to oxygen. This coating can be damaged by abrasive materials such as steel wool, sand paper, and other cleaning materials that are abrasive. Chlorine salts, sulfides, or other rusting metals can also erode this thin coating exposing the metal to corrosion. The best defense to combat corrosion on stainless steel components in your spa is make sure that it is kept clean and free of any chemical build up.

Always:

- Clean frequently with fresh, clean water.
- Remove any rust spots as soon as they appear with vinegar or a stainless steel, brass, silver, or chrome cleaner.
- Use a good car cleaning wax for extra protection.
- Leave cover removed for at least 15 minutes after adding chemicals to the spa water

Never:

- Clean with mineral acids or bleaches, steel wool or any other abrasive materials.
- Leave in contact with iron, steel any other metals.
- Close the cover immediately after adding chemicals to the water.

NOTE: Failure to take proper care of the stainless steel could result with them rusting. Rusting is not covered by the warranty.

NOTE: Do not cover the spa for 15 minutes after adding chemicals as the off gas can cause unwarranted damage. Larger dosages can require longer lengths of time to off gas. It is recommended to check spa water more frequently to allow small dosages be added as necessary versus large dosages being added less often.

SPA TROUBLESHOOTING GUIDE

NOTE: For wiring outside of U.S. and Canada, GFCI may be referred to as a RCD (residual current device). Be sure all local electrical codes are followed.

GFCI IS TRIPPING

A ground fault circuit interrupter (GFCI) is required by the National Electrical Code for your protection. The tripping of the GFCI may be caused by a component on the spa or by an electrical problem. Electrical problems include but are not limited to, a faulty GFCI breaker, spa component, power fluctuations, and/or improper wiring. If this is a new electrical service and GFCI installation, an instantly tripping GFCI may likely be caused by improper wiring of the load neutral from the GFCI to the spa. It may be necessary to contact an electrician if your Master Spas dealer recommends doing so.

NOTHING ON THE SPA OPERATES

1. Check the control panel display for any messages. If there is a message, refer to the diagnostic section on that spa model. There you will find the meaning of the message and what action is to be taken.
2. If there is no message on the control panel and the control panel is completely dark (off), try to reset the GFCI breaker.



The GFCI should be located in a weather proof box close to the spa, but no closer than 5 ft.

If the spa does not respond, or the GFCI breaker continues to trip, contact your Master Spas dealer or service organization.

SPA NOT HEATING

If the spa's heater has failed, the majority of the time it will trip the GFCI breaker. If the spa is not heating and has not tripped the breaker, please follow these steps:

1. Check set water temperature at control panel to make sure it is set to desired temperature and above the current water temperature.
2. Check the "Heat Mode" that the spa is set in. The spa should be set in the Standard Mode or Ready Mode depending on the model. If placed in an Economy or Rest type mode, it changes the way the system heats and will primarily only heat during user programmed durations. See Spa Control section for further details.
3. Check the control panel for heat indicator. If heat indicator is on, wait a reasonable amount of time (at least 1 hour for 240V systems or 3-4 hours for 120V systems) to see if the water temperature is rising.
4. If heat indicator does not remain on, the system should be displaying a message indicating why it can't heat. Check the control panel for diagnostic messages. Refer to Spa Control Section titled System Related Messages. Follow steps to alleviate the message.
5. Reset power to the spa at GFCI breaker.
6. If spa is still not heating, contact your Master Spas dealer or service organization.

SPA TROUBLESHOOTING GUIDE

WATER TEMPERATURE IS ABOVE SET TEMPERATURE (HEAT CREEP)

Because Master Spas hot tubs are well insulated and built to meet stringent energy standards, heat creep can occur. This means that the measured temperature of the water in your spa is creeping up higher than the set temperature on your control panel. Heat creep can occur as outdoor temperatures become moderate to warm or when your filter cycle durations have been adjusted above the default settings. To help manage heat creep:

1. **Vent your cover.** This means placing a folded cloth about $\frac{3}{4}$ inches (2 cm) thick under all four corners of the cover before you lock the cover down.
2. **Open your cover.** Opening the cover at night will also quickly cool the water down if desired.
NOTE: Never leave a spa cover open and unsupervised.
3. **Open all air controls.** Temporarily leave the air controls open during cooler times of the day or night. Set your filtration cycles to run during this time as well.
NOTE: If the heat creep issue has been resolved, close the air controls when not using the spa to reduce energy and chemical maintenance.
4. **Reduce the length of your filter cycles.** The default duration is generally 4-4.5 hours of filtering per day (either a duration of 2 hours that occurs twice per day or one 4.5-hour filter duration based on time of day).
5. **Visit your local Master Spas dealer for additional guidance.** Heat creep can happen on well-insulated hot tubs, and is related to the environment where the spa is installed and equipment runtimes such as extended filter cycle durations (especially on systems using Therapy Pump 1 low speed for filtering and heating). This is not indicative that there is a problem with the spa.

PUMP(S) DO NOT OPERATE

1. Press the “Jets” button on your control panel.

If you hear the pumps trying to operate:

- A. Check that all the slice valves are open.
- B. Pump may be air locked and needs to be primed.

Refer to Installation Instructions section. If you do not hear anything from the pump, contact your Master Spas dealer or service organization.

NOTE: If the pump(s) had been operating for 15 minutes or longer prior to ceasing operation, it may be normal and simply related to mild or warmer temperature conditions and excessive internal temperatures occurring from prolonged pump run-times. The spas are built to meet stringent energy efficiency standards and to run at full capacity during the 15 minute safety timeout periods. Operating pumps at high speed repeatedly beyond the 15 minute timeout can result in the pump motor getting too warm and shutting itself off to cool down. This would be seen by the control indicating the pump should be on still, but the pump has shut itself off internally. If this thermal cutout occurs, the pump will remain off for several minutes to cool. Once the equipment area and motor cool down, it would begin operating again.

POOR JET PERFORMANCE

1. Make sure pump is operating.
2. Check that the water level is adequate (up to minimum safe water level on sticker located near filter or at least 1” above the filters or filter housing opening).
3. Make sure the jets are open and the air controls are open. Refer to Glossary of Spa Terminology section.

WINTERIZING & STORING YOUR SPA

WINTERIZING YOUR SPA

Your spa is designed to be used year round in any type of climate.

However, if you decide you don't want to use your spa in the winter, you must drain it and follow the winterizing steps listed below.*

DISCLAIMER: Master Spas does not recommend winterizing your spa. If you choose to do so, any damage that may result is not covered under the spa warranty.

1. Drain your spa completely using the drain valve (if so equipped) or use an inexpensive submersible pump that you can buy from your local hardware store.
2. Use a shop vac to get all standing water out of your unit.
3. Remove access panels from equipment area.
4. Loosen all pump unions.
5. Remove winterizing plug from face of the pump(s) where applicable.
6. Using your shop vac in a blowing mode, insert the hose into the nozzle of each jet and blow the trapped water from the lines into the interior of the spa. A non-toxic, RV water line type antifreeze can be used and added to jets in each seat around your spa to help prevent freeze damage from occurring. Be sure to thoroughly flush the system before startup.
7. After this is completed, use the shop vac to remove any standing water in the spa and in the equipment area.
8. Clean the spa with a soft cloth and a non-abrasive spa surface cleaner.
9. Replace access panels.
10. Cover the spa to prevent water from entering it and check the spa periodically to be sure no water is entering and accumulating. Spa covers are a great insulator but will allow some precipitation to enter the spa. For this reason, it is highly advised to also cover the spa with a water tight tarp while winterized. It is beneficial to keep the spa cover slightly gapped off the acrylic shell while winterized to allow air flow in to the shell area to reduce mildew/mold buildup caused by trapped moisture.

* If you decide to winterize your spa, we recommend that you periodically check the spa throughout the winter to assure water is not entering the spa through or around the spa cover.

STORING YOUR SPA

The spa shell should never be left unprotected and uninsulated while being stored. Clear plastic wrap or similar material should never be used to cover/protect the spa.

Prolonged, direct sun heat can damage the surfaces of the spa along with any components on the spa's surface. Always keep the spa covered and protected with an insulating spa cover. Resulting damage such as cracking in the shell surface, warping or discolored components on the spa would not be warranted.

An empty spa should never be exposed to temperatures below 0°F (-18°C) after delivery as extreme cold can cause shell damage. This includes storage and draining (winterizing). If your spa will be exposed to these temperatures, keep the unit filled and running. If you do not plan to use your spa, you can set the spa to the lowest temperature setting allowed by the control system while in Standard/Ready Mode.

Failure to adhere to these guidelines may result in unwarranted damage caused to the spa.

MODEL SPECIFICATIONS

MODEL	LISTING NUMBER	SPA DIMENSIONS (in./cm)	ELECTRICAL REQUIREMENTS ¹	SEATING CAPACITY ²	WATER CAPACITY (gallons/m ³) ³	DRY WEIGHT (lbs./kilos) ⁴	FULL WEIGHT (lbs./kilos) ^{3,4}	THERAPY PUMPS
MPL 700	1280	84" x 84" x 38" 214 x 214 x 97	Configuration # 2 240V, 50A GFCI	5	305 / 115	1095 / 497	4565 / 2071	3
MPL 800	1290	94" x 94" x 38" 239 x 239 x 97	Configuration # 2 240V, 50A GFCI	6	410 / 155	1330 / 603	5860 / 2658	3
MPL 850	9923	94" x 94" x 38" 239 x 239 x 97	Configuration # 2 240V, 50A GFCI	7	395 / 150	1170 / 531	5760 / 2613	3
MPL 900	1310	108" x 94" x 38" 275 x 239 x 97	Configuration # 2 240V, 50A GFCI	8	490 / 185	1485 / 674	7055 / 3200	3

¹As configured from factory. See appropriate Electrical Requirements section for further details.

²Total bather capacity in spa. The number of bathers in spa should never exceed indicated seating capacity. Depending on spa size, water level and bather displacement, full seating capacity may not be achievable. Do not allow additional bathers to enter if bather displacement results in water levels overflowing or reaching the spa controls (air controls, diverters, spa topside control and etc.) as this will result in water leaking out of the spa shell and potentially in to the equipment area.

³Full weight based on dry weight of spa, max seating capacity of spa, assumed average weight per person of 185 pounds and estimated water weight of 8.34 pounds per gallon. Rounded up in increments of 5.

⁴Manufacturing tolerances along with other factors can result in variance in actual spa weight. If weight is a critical figure necessary for delivery, or final installation, we suggest a minimum of 15% be added to the listed weight when planning delivery or installation.

Portable spa installation is simple when properly planned. It is important that you read the following information carefully and consult with your Master Spas dealer.

- 1. ACCESS:** The actual dimensions of your new spa will determine the amount of space that is needed in moving the spa from curbside to its final installation area. Be sure to consider and measure side yard dimensions, gates, doors, overall room dimensions and vertical obstructions such as ceilings, roof overhangs, balconies and overhead cables. Any other space limiting obstacles such as stairs, trees, and shrubs must also be evaluated. Consideration should also be taken to ensure there is convenient water supply for filling your spa (review national and local regulations). The desired location for spa might require use of a crane. Please be sure to contact and review these site and installation plans with your Master Spas dealer prior to delivery. It is also good to consider these access requirements for ease of removing the spa from the premises in the event it is necessary to do so.
- 2. SURFACE/PAD REQUIREMENTS:** When your new spa is filled with water and bathers, it may weigh as much as several tons. It is imperative that the base beneath the spa can support the entire weight. The spa must be on a uniformly firm, continuous, and level surface. The recommended foundation is a concrete pad with a minimum thickness of four inches with steel reinforcement bars crossed throughout the pad.

IMPORTANT

Consult experts and/or local authorities to review and comply with all local and national laws and regulations relating to childproofing, safety barriers, lighting and any other safety requirements at site. When installing your spa indoors, on a wood deck, roof or balcony, load requirements need to be evaluated before installation. It is also good to consider location and position of spa as well as surfaces and foundation to minimize noise disturbance as much as possible. You should speak with a qualified contractor or your local building department to confirm that your surface is adequate for supporting the spa and conforms to these guidelines.

All sides of the spa must be accessible for regular maintenance or in the event that service is needed. Periodical maintenance checks require entry into the equipment bay. When possible, it is wise planning for the future to leave 3 feet of access to all sides of the spa in the event your spa requires maintenance. Your spa warranty does not cover the cost of providing access for service.

GENERAL CONSIDERATIONS FOR OUTDOOR INSTALLATION

Again, proper planning will increase your total enjoyment factor with your new spa. Listed below are some additional items to consider when planning your installation.

- Local building codes (if applicable)
- Power cable
- Appropriate materials and drainage around the spa to handle water presence and runoff
- Consider local environmental conditions, such as ground water and risk of frost
- In cold climates, an insulating ground cloth can be installed between foundation and spa to minimize heat loss
- How spa will complement landscaping and vice versa
- View from inside spa and view of spa from inside of home
- Exposure to sunlight and shading from trees

SITE PREPARATION/GENERAL GUIDELINES

GENERAL CONSIDERATIONS FOR INDOOR INSTALLATION

Installing your spa indoors creates an entirely different set of considerations.

- Privacy
- Getting to spa from the house and back
- Proximity to dressing rooms and bathrooms
- Storage for spa chemicals
- Work with your Master Spas dealer and contractor to insure all local building, electrical and plumbing codes are met
- Plan for proper flooring and floor drains around your spa to drain off excess water runoff that will occur during normal use and for draining and cleaning your spa
- Proper room ventilation and dehumidification
- Finished materials in your spa room should also be capable of withstanding increased humidity and moisture

GUIDELINES FOR PARTIALLY OR FULLY RECESSED INSTALLATION

Spas manufactured by Master Spas are designed to be installed in a variety of settings. One of which is installing below grade. Should a spa be installed below the level of the site drainage system (below grade), a system for preventing water collecting and pooling must be designed based on the requirements of the local authority having jurisdiction. The drainage system must be designed based on things such as rainfall, water runoff, splashing, draining the spa, etc., that could potentially feed the below grade area with water. When located in designated floodways, additional attention to maximum water load entering the area below grade must be addressed to prevent water from accumulating below grade at all times. It is generally recommended that the spa be installed above grade because the spa is not designed to be submerged in water. When a proper drainage system is designed and proper ventilation is planned based on the characteristics of the site, installing the spa below grade is an accepted method of installation.

- The unit is self-supporting when placed on a surface designed to support the full load of the spa (see Surface/Pad Requirements). Do not backfill with sand, gravel, or earth. Doing so will void the warranty.
- Plan for complete drainage so that water accumulation drains away from the spa perimeter and standing water never reaches the electrical equipment.
- Plan for appropriate ventilation to remove moisture accumulation and to prevent equipment from overheating.
- Provide a minimum of 3 feet service area around the perimeter of the unit. Site access issues are not covered by the product warranty.
- The unit is not designed to be submerged in water. Water entering the equipment area creates many hazards and resulting damage will not be covered by the product warranty.
- Make sure that the surroundings do not create any additional hazards.
- Surfaces placed around the unit should also be evaluated for walking/slipping hazards from standing water. Proper drainage is vital to the installation of a below grade installation.
- Check all building, electrical, and plumbing codes with the authority having jurisdiction to ensure that your installation is in compliance with all local codes.
- Additional consideration needs to be made when installing unit in designed floodways.
- Verify that site specific drainage systems such as down spouts are not going to feed the area below grade.
- Below grade drainage system needs to be evaluated based on area specific rainfall. One size does not fit all so an analysis by a qualified, local engineer to ensure proper drainage of all sources of water is a must when installing below grade.

SITE PREPARATION/GENERAL GUIDELINES

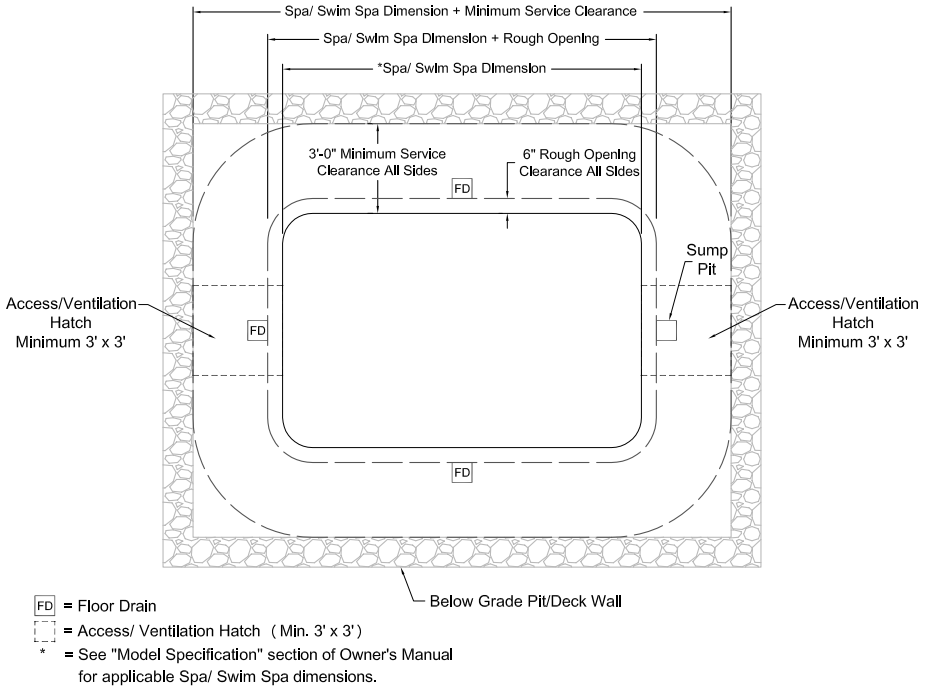

ELECTRICAL REQUIREMENTS

CONFIGURATION 2 - 240V, 50A GFCI

NOTE: Electrical requirements by model is shown in Model Specifications. Only electrical configurations pertaining to the models referenced in this manual are shown.

ELECTRICAL REQUIREMENTS

HAVE YOUR ELECTRICIAN READ THE FOLLOWING INFORMATION BEFORE INSTALLATION BEGINS

Electrical connections made improperly, or the use of wire gauge sizes for incoming power which are too small, may continually trip breakers, blow fuses in the electrical equipment box, damage the internal electrical controls and components, be unsafe and, in any case, will void your warranty.

It is the responsibility of the spa owner to ensure that electrical installation supplying, and connecting to the spa, is performed by a properly qualified, licensed electrician in accordance with the with all applicable local, regional, state requirements, and current effective edition of the National Electrical Code at the time of installation. Due to product being built to comply with varying countries, regions and related standards, there may be labels on the product with specifications for installation/wiring that may not apply to your country or local standards. Refer to local, applicable standards.

These connections must be made in accordance with the wiring diagrams found inside the control box. This equipment has been designed to operate on 60Hz. alternating current only, 120/240 volts are required. Make sure that power is not applied while performing any electrical installation. A bonding lug has been provided on the electrical equipment pack to allow equipotential bonding connection for bonding conductors. The bonding conductor shall be at least 10 AWG copper and must be connected according to the current effective and applicable local, regional, state and edition of the National Electrical Code. The spa requires a 50-amp, single phase, 120/240 volt, four wire supply (two ungrounded line conductors, one grounded neutral conductor and one grounding conductor). The disconnect must be readily accessible to the spa occupants but installed at least five feet from the spa. A Ground-Fault Circuit Interrupter (GFCI) must be used to comply with section 680-42 of the National Electrical Code. A ground fault is a current leak from any one of the supply conductors to ground. A GFCI is designed to automatically shut off power to a piece of equipment when a ground fault is detected, and, its operation, should be tested frequently before use.

The electrical supply to the spa must be an individual branch circuit 120/240V, 50A, 4 wire, with ground (#6 AWG copper with minimum #10 AWG copper ground).

Route the electrical supply into the equipment area, by cutting an appropriate opening either through the bottom or side cabinet, for final hook-up to terminals inside the spa control system. The spa must be connected to an "individual - dedicated" 120/240-volt, 50-amp breaker and GFCI. The term "individual - dedicated" means the electrical branch circuit for the spa is not being used for any other electrical loads (i.e. patio lighting, appliances, garage circuits, etc.). If the spa is not connected to an individual-dedicated branch circuit, overloading may result in "nuisance tripping" which will require resetting of the breaker at the house electrical panel.

202412

ELECTRICAL REQUIREMENTS

CONFIGURATION 2 - 240V, 50A GFCI

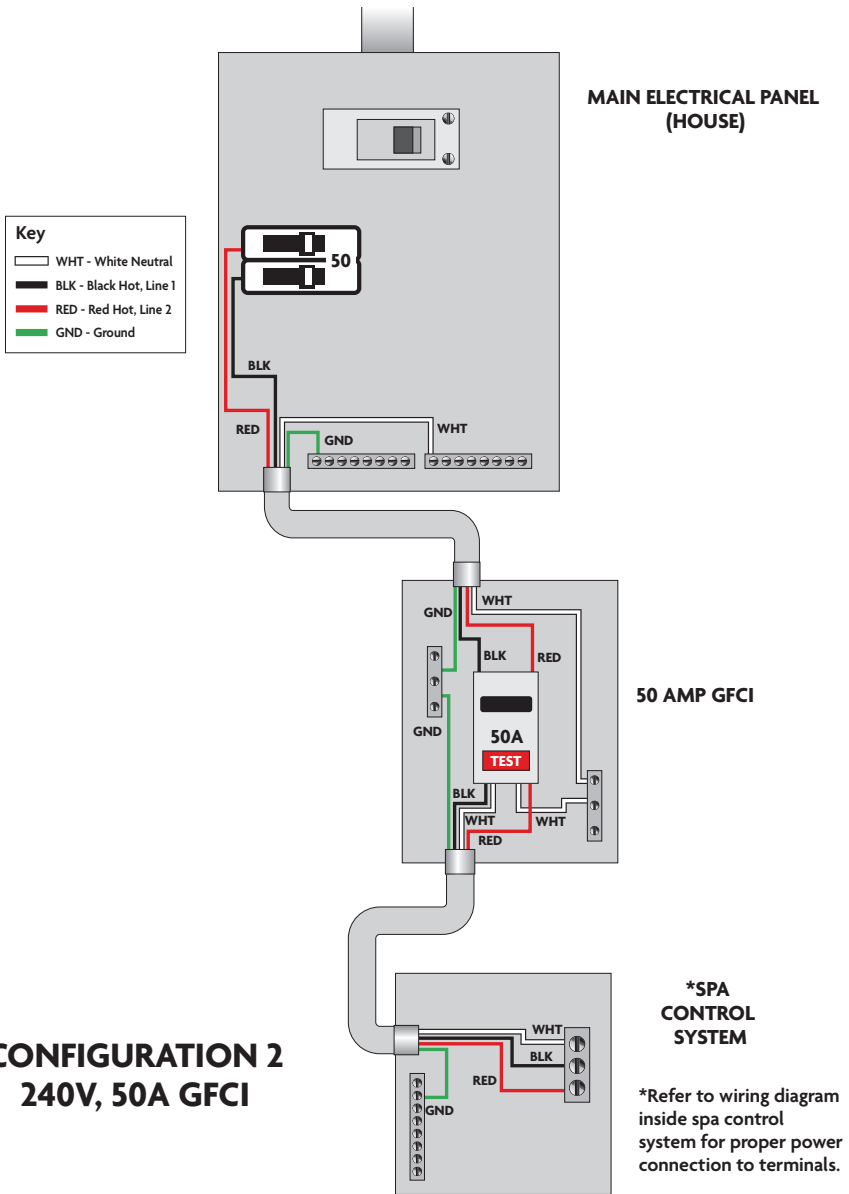

SKIRT CABINET PANEL REMOVAL

The skirt cabinet panels on your hot tub will need to be removed during initial installation and startup as well as for regular inspection and maintenance of the internal components. The front skirting panel, typically located beneath the topside control panel, is the most common panel needing removed for access to the main electrical equipment. Make sure the spa is off before opening up the skirting cabinet and disconnecting the LED connections.



1. The skirt cabinet panels are secured with transport clips (highlighted in red) at the bottom to prevent the panels from jarring free during shipping. The first step is removing these clips. There is a single screw holding each clip to the frame. Remove the screw using a #1 square head bit and slide the clip toward the center of the panel. Once the clip is slid all the way over to the larger rectangle opening in the back of the panel, pull down and out to remove. There will be 2 transport clips per main side panel. Do this for both clips located at the bottom of each skirt panel needing removed.

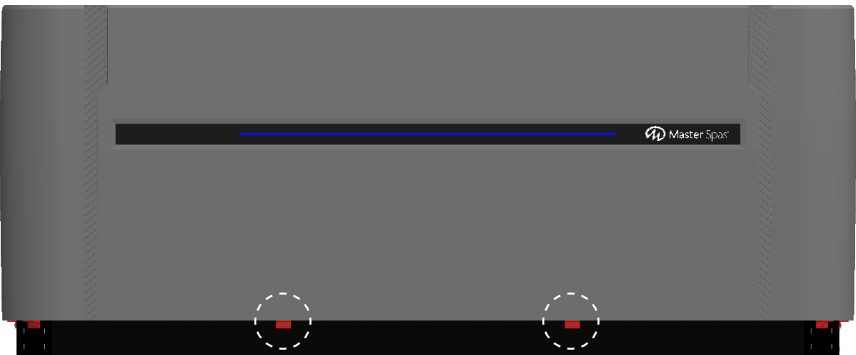
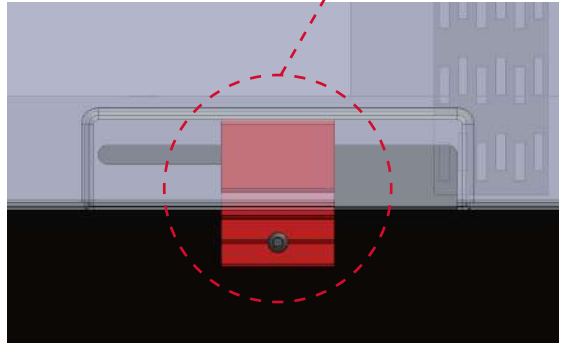

SKIRT CABINET PANEL REMOVAL

3. To remove a main side panel, you will also need to remove the associated corner panels that overlap the panel at its ends. Each corner also has a transport clip that needs removed. Remove the screw, slide the clip to the left and pull the clip down and out to remove.

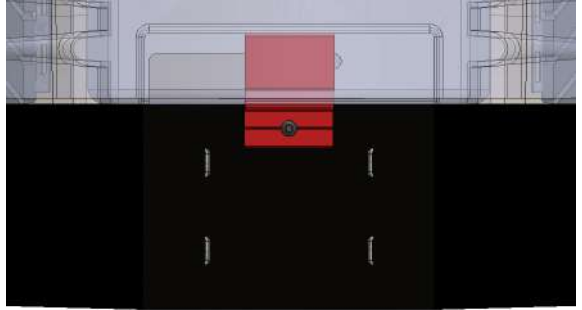

4. Once the transport clip has been removed, the corner can be pushed up, pulled away from the spa frame, and removed. This process lifts the corner skirt panel off the French cleats (highlighted in blue) that it hooks into.



5. The main skirt cabinet panels are removed in a similar manner. Lift from the bottom of the panel and then pull out as the panel drops downward to disengage the skirting from the French cleats that hold it.

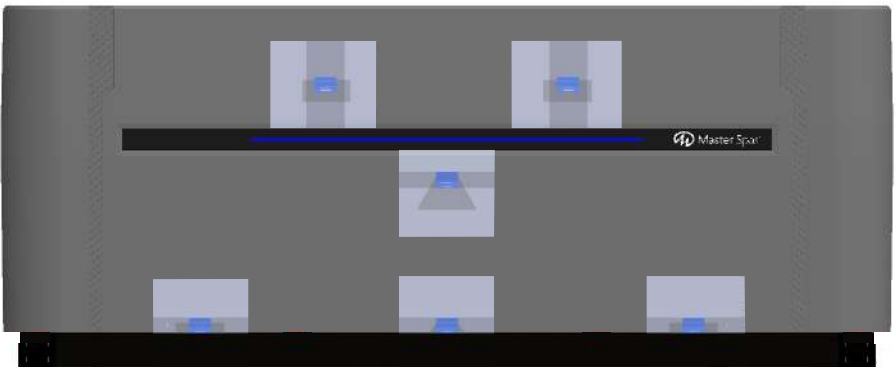

SKIRT CABINET PANEL REMOVAL

- Before removing the panel away from the spa, reach behind and disconnect the LED cabinet lighting. The front cabinet panel with the light up Master Spas logo has two types of connections. The right side with the logo has two spade connectors, connecting to supply power. The opposite side has a low voltage light harness connector. The other cabinet panels will only have the the low voltage light harness connection at each end, to connect the rest of the panel lighting in series.



Low Voltage Lighting Harness

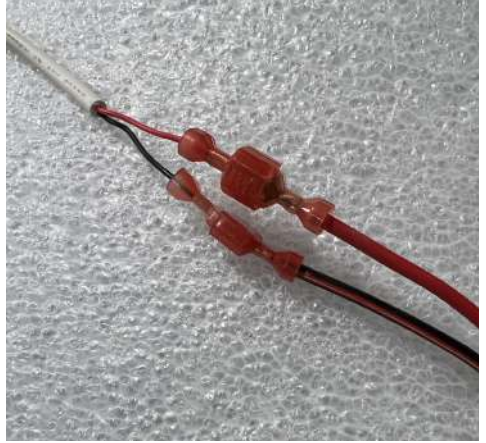

Low Voltage Lighting, Supply Connection

- Once the work inside the spa is done, reverse these steps to reinstall the skirt cabinet panels.
 - Hook the cabinet LED lighting back together. Connect both low voltage lighting supply connectors, red to red and black to black. Hook up the low voltage lighting harness on the opposite end of the cabinet panel.
 - Line up the panel with the French cleats on the spa frame.
 - Lift it up into the flange of the spa shell and let it settle in place on the French cleats.
 - Line up each corner with the French cleats on the frame.
 - Lift it into the flange of the shell and let it settle on the French cleats.
 - Once the skirt cabinet panels are back in place, reinstall the transport clips, if desired, to deter unauthorized access to your spa's equipment area.

▶ **WATCH HOW-TO VIDEOS:** masterspas.com/video-tutorials

SETUP STEPS

1. Put spa in final position that allows for access to equipment and spa components. Master Spas recommends that at least 3 feet of space be provided around all sides of the spa for access. This provides adequate space for regular maintenance and service.
2. Remove front skirt panel (this is the side where the topside control panel is located) so electrical can be hooked up to the spa control system. Remove the shipping clips on the front skirting cabinet panel and the corners on each side. Lift each corner up and remove. Lift the front skirt cabinet panel up and down. Reach behind and unhook the LED power and light harnesses for the skirt cabinet lighting. For more detail check out the Skirting Cabinet Removal section.
3. With the front skirt panels removed allowing access to the equipment, be sure all pump and heater unions are secure. Each pump has 2 unions and the heater has 2 unions. A newly delivered spa may have loose unions caused in transporting the spa. Check that all slice valves are open, in the up position. The slice valves may become closed during transportation of the spa.

4.  Fill spa to minimum water level label indication located on the spa shell near the filter area or at least 1' above the filters or filter housing opening. We recommend filling the spa through the filter area to help reduce air locks from occurring in the filter and heating pump. When filling or topping off water, do not exceed the maximum fill level indication on the water level label.

Slice Valve and Pump Union

- NOTE:** In below freezing temperatures, caution should be taken when planning to install a spa and fill it with water. As it takes time for the water to fill the spa and reach the proper minimum water level, the water entering the various plumbing lines and equipment may begin to freeze up when done in winter weather conditions. This could result in pumps being seized until thawed or other potentially worse freeze damage occurring to the equipment and plumbing lines.
5. Turn the power on to the spa. Once the system and control panel loads to operational state, activate each jet pump to ensure they are not air locked before the system continues normal heating and filtering operations. See the spa controls section of this manual for additional instructions on control startup.
 6. Be sure the adjustable jets in your spa are open by turning the face of the jet. Most of the jets in your spa are adjustable and removable by turning the face of the jet.

INITIAL SPA SETUP

- It may be necessary to bleed air from the pump(s) in your spa if, after start up, your spa pumps are turning on and off but you do not have water flow from the jets in your spa. Due to the nature of water flow and hydro-therapy pumps, please be advised that air locking of pumps may occur. Master Spas has taken measures to reduce the possibility of this, but it still may occur, especially after refilling a spa. This is not a service covered under warranty and service charges may apply.

To relieve an airlock situation, loosen the pump union on the discharge of the pump as it tries to prime. This pump union is indicated by an arrow in the picture below. Water should leak out of the union once the air has been removed. Tighten the union and test the pump for proper operation. Repeat this process if needed.

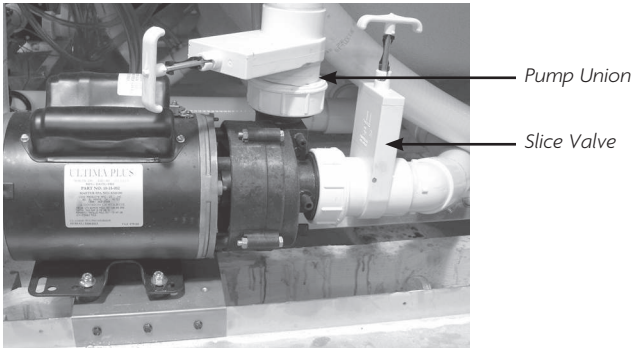

Airlock

- Adjust water chemistry according to the instructions provided in the Water Maintenance section.
- *Your spa water will heat approximately 3 to 4 degrees Fahrenheit per hour (1 to 2 degrees Celsius) with the cover placed on the spa. This varies depending on the size of the spa and ambient temperatures.
- Step into the soothing waters of your Master Spa!
Relax and enjoy.

*240V systems only. 120V spa models increase at approximately 1°F per hour (can vary depending on model and temperature conditions).



WATCH HOW-TO VIDEOS:
masterspas.com/video-tutorials

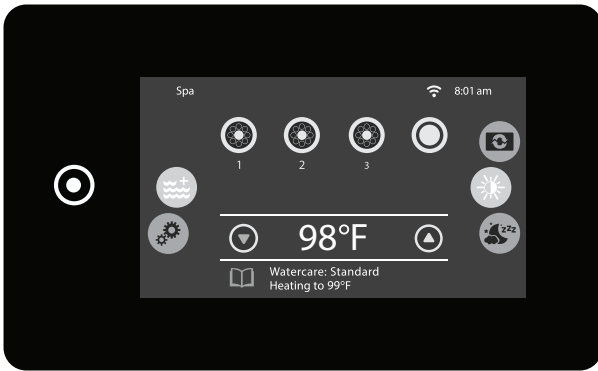

SPA CONTROLS - GECKO in.k1000+

THE MAIN SCREEN

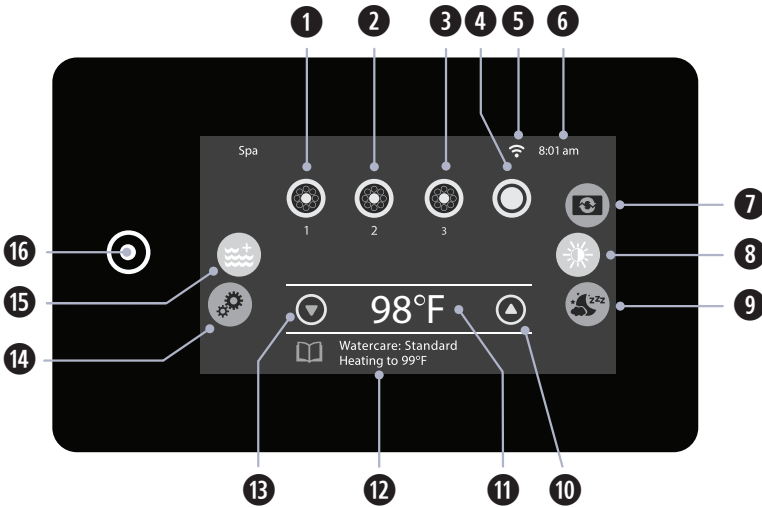

SPA STATUS

Various information and menus can be viewed and accessed through the main screen on your spa. This will include status of the spa and water temperature along with options such as settings menus, water temperature adjustment, messages and alerts. The Spa Equipment Control Icons can be viewed in the middle of the default spa menu home screen. There are menu wheels on each side of the screen that allow you to move through the various menu options. At the bottom of the screen you can view any error or maintenance message. The control panel also includes an all-on/all-off key that is located to the side of the screen.

ICON SPECIFICATIONS

- | | |
|-------------------------|--|
| 1 Pump 1 | 9 Sleep Mode |
| 2 Pump 2 | 10 Set Temperature Up |
| 3 Pump 3* | 11 Water Temperature |
| 4 Lights (On/Off)** | 12 On-Screen System Messages & Reminders |
| 5 Wifi (if equipped)* | 13 Set Temperature Down |
| 6 Time of Day | 14 Settings Menu |
| 7 Display Orientation | 15 Spa Menu |
| 8 Display Contrast Page | 16 All-On or All-Off Key |

NOTE: After 30 minutes the display will automatically go into sleep mode, which turns the display off. This is normal operation. Touch anywhere on the screen to wake the control panel up.















*If equipped. Equipment and options vary by model.

**If equipped. 19' models with dual bodies of water (swim side and separated hot tub side) have 1 main lighting control that is typically operated through the spa side control panel only. The other equipment control panel(s) would not physically operate the lighting.

SPA CONTROLS - GECKO in.k1000+

ICON DESCRIPTION

ICON SPECIFICATIONS

-  = **Pump 1:** Allows you to control the speed of Pump 1.
-  = **Pump 2:** Allows you to control the speed of Pump 2.
-  = **Pump 3:** Allows you to control the speed of Pump 3 (if equipped).
-  = **Lights ON**  = **Lights OFF**
-  = **Wi-Fi:** If equipped you will see this icon. (Feature: After market addition)
- Time of Day:** Shows the time you have preset.
-  = **Display Orientation:** Invert or flip screen.
-  = **Display Contrast Page:** Allows you to switch between Day and Night Contrast.
-  = **Sleep Mode:** Allows user to put the screen to sleep and prevent water splashing causing accidental input.
-  = **Set Temperature Up:** Adjust set temperature higher.
- Current Water Temperature:** Displays current water temperature in °F (Fahrenheit) or °C (Celsius).
- On-Screen System Messages & Reminders:** Messages and reminders appear here.
-  = **Set Temperature Down:** Adjust set temperature lower.
-  = **Settings Menu:** Allows you to access the Settings Menu options.
-  = **Spa Equipment Menu:** Show you the equipment icons for operating your spa.
-  = **All-On or All-Off Key:** You have the ability to turn on all the pumps by touching and holding this button and also turn all the pumps off by touching and holding.

SPA CONTROLS - GECKO in.k1000+

THE MAIN SCREEN

NAVIGATION

Navigating the entire menu structure is done by using the selection wheel on the left to select a main menu control screen. Touch one of these main menus or use the sub menu scroll wheel on the right side of the screen to enter in to various additional controls and settings.

Most menu screens time out and revert to the main screen after 30 seconds of no activity.

Spa Main Menu Example

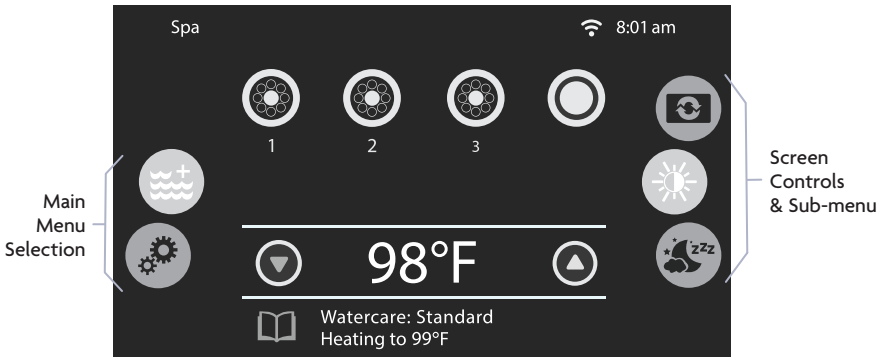

Settings Main Menu Example

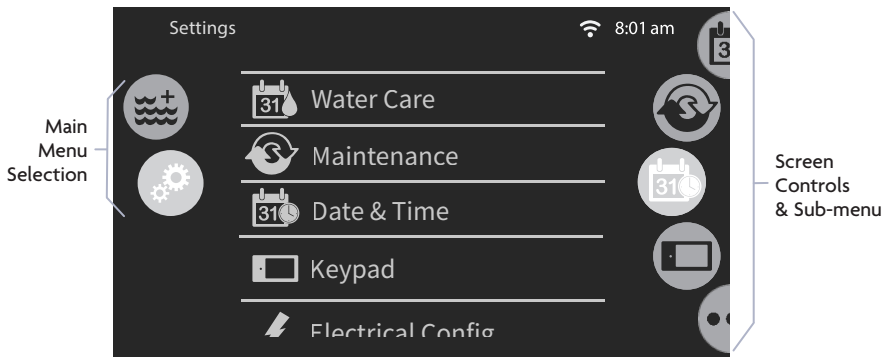

SPA CONTROLS - GECKO in.k1000+

LIGHTS ON/OFF

START OR STOP ACCESSORIES

To start or stop an accessory, touch the associated icon. Icons will become animated or change appearance when their accessory is turned on. Animation will stop or icon will revert back to inactive appearance when turned off. Some icons on the screen will reflect the speed or state (such as a pump having 2 speeds, low and high) of the devices running on your spa. When an accessory has more than one state, press the button until it reaches the desired state (i.e. a 2 speed pump could be set to low speed, high speed or back to off).

LIGHTS OFF

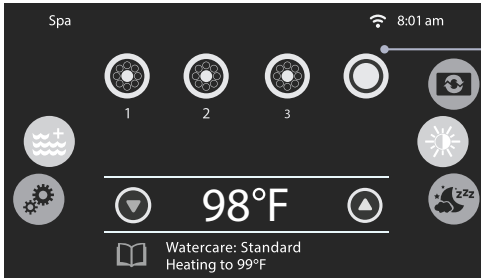

For example, the Lights icon is not selected. To activate the lights press the associated icon.

LIGHTS ON

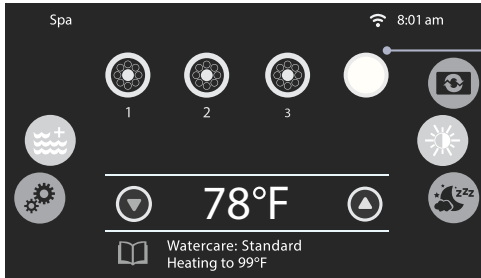

Lights have been turned on. The Lights icon will go from grey to yellow showing it's in use.

SPA CONTROLS - GECKO in.k1000+

PANEL NAVIGATION

SLEEP MODE

The touch screen will go to sleep after 3 minutes of no interaction. Or, you can put it in sleep mode by using the . This occurs to simply allow the screen to be shut off during periods of no use as well as prevents water splashing from causing undesired input while in use.

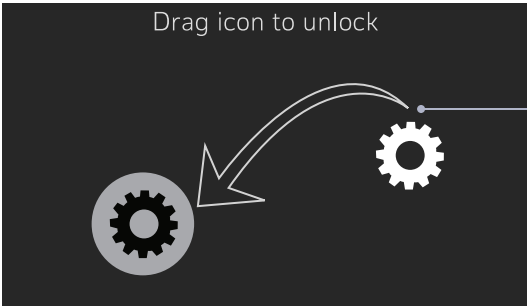

Touch the screen to wake the screen. Then, drag the white icon to the colorful icon to unlock the screen.

WATER TEMPERATURE

The larger displayed temperature shown at the bottom of the screen indicates the current water temperature. Use the Up and Down Icons to set the desired temperature. The set point will appear in blue. After 3 second without any change to the set temperature value the current water temperature will reappear in white.

When the set value is lower than the current water temperature **Cooling to xx.x* will appear below. When the set value is higher than the current water temperature, *Heating to xx.x* will be indicated under the value.

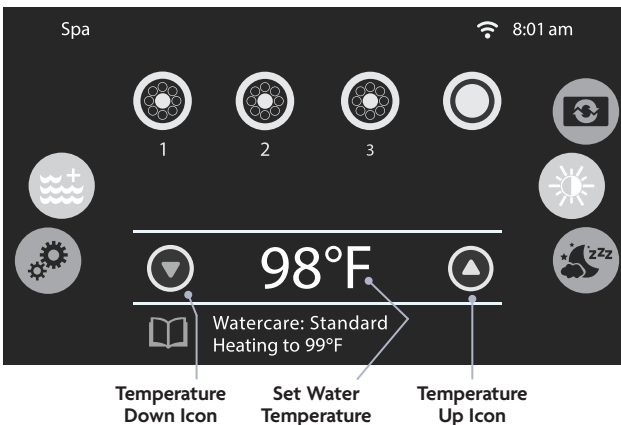

*Standard systems do not have physical capabilities of cooling the water. Water cooling and achieving lower set temperature will be dependent on ambient conditions and equipment runtime such as filtration durations.

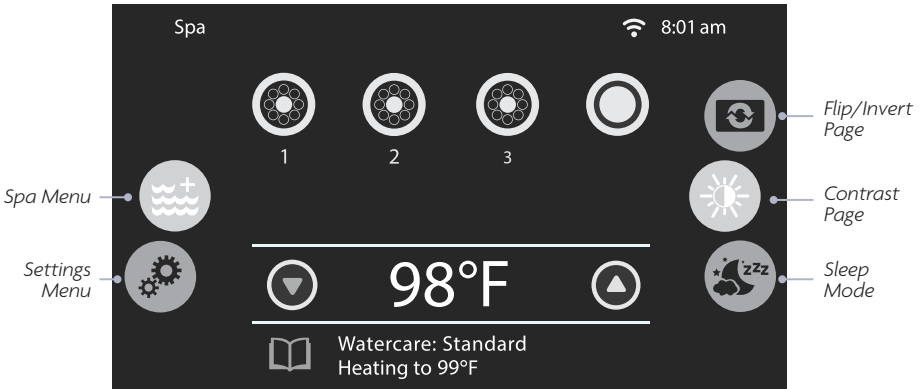

SPA CONTROLS - GECKO in.k1000+

MENU & SETTINGS



SPA MENUS

From the home page you can access the following:

-  Spa Equipment Control Menu
-  Settings Menu

To select an option, slide the left wheel up or down until the desired icon menu is highlighted in the middle. On the right side is a menu for access to the Display and Contrast pages while in the main Spa menu. This selection wheel will change as accessing different main menu like Settings.

FLIP/INVERT DISPLAY

The Display Menu Icon  takes you to the display orientation options. The two options available are Normal and Inverted.

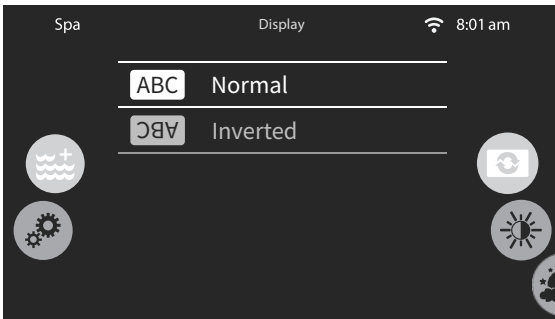

Inverted screen display orientation allows you to flip the display 180 degrees.

SPA CONTROLS - GECKO in.k1000+

SPA MODES

CONTRAST PAGE

The Contrast Page Icon  takes you to the Contrast Page options. The two options are *Day Contrast* and *Night Contrast*.

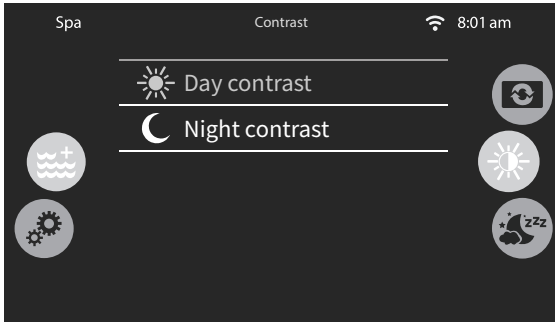

Day Contrast has more saturated colors with a darker background, which makes it easier to see the screen if and when it's sunny.

Night Contrast has a lighter background making it easier on the eyes in lower light.

SLEEP

The Sleep Mode Icon  takes you to the page to put your keypad into sleep mode. Press the icon in the middle of the screen to put your keypad into sleep mode immediately.

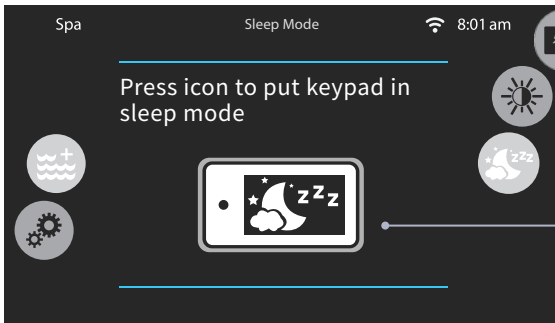









By pressing this icon, your keypad will immediately go into sleep mode.









SETTINGS

SETTINGS

Icons will be highlighted when selected:

-  *Water Care*
-  *Maintenance*
-  *Date & Time*
-  *Keypad*
-  *Electrical Configuration*
-  *Wi-Fi*
-  *Miscellaneous*
-  *About*

Icons will be darker when deselected:

-  *Water Care*
-  *Maintenance*
-  *Date & Time*
-  *Keypad*
-  *Electrical Configuration*
-  *Wi-Fi*
-  *Miscellaneous*
-  *About*

To select an item, slide the right wheel until the desired icon is highlighted in the middle or press on the menu name.

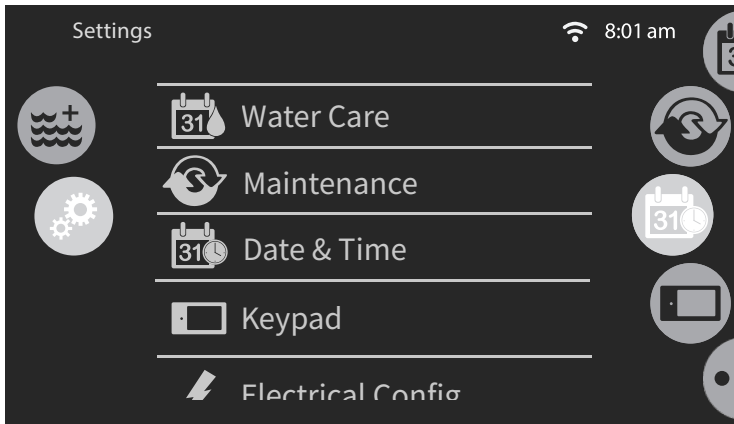

SPA CONTROLS - GECKO in.k1000+

WATER CARE SETTINGS

WATER CARE

The Water Care page will help you set up your ideal filtration and heating settings. Choose between *Away from Home*, *Standard*, *Energy Savings*, *Super Energy* and *Weekender*, depending on your need. Touch the Water Care name to choose your setting. Changing water care modes will alter how your spa maintains set temperature as well as the filter/purge timing. Upon selection to change these modes, it will ask you to confirm the change. Once confirmed, a green check mark will appear on the current water care mode selected.

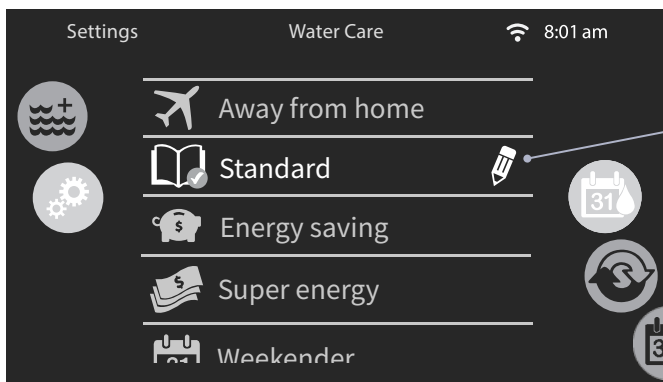

Pencil Icon:
Allows editing to
Water Care Settings

WATER CARE MODES

Below is an explanation of each mode available under the Water Care Settings. These modes alter how and when the spa will heat. During "Economy" timing, the spa will maintain water temperature at 20°F below that of your current set temperature. Entering in to each mode and selecting the edit icon  on the touch screen will allow detailed view of the "Economy" mode operation timing along with the Filtering/Purge cycle timing for each Water Care mode.



Away from Home:

In this mode the spa will always be in economy; the set point will be reduced by 20°F.



Standard:

This is the default mode from factory. In this mode the spa will continually maintain set water temperature as needed. The spa will also perform filtering and purge cycles according to default settings (unless altered by user).



Energy Savings:

The spa will be in economy mode during the peak hours of the day and resume normal heating to the set temperature during the evenings as well as all day on the weekend.



Super Energy Savings:

The spa will always be in economy mode during the peak hours, every day of the week (maintaining normal set temperature only during the evenings).



Weekender:

The spa will be in economy mode from Monday to Friday, and will run to maintain set temperature on the weekend.

SPA CONTROLS - GECKO in.k1000+

WATER CARE SCHEDULES

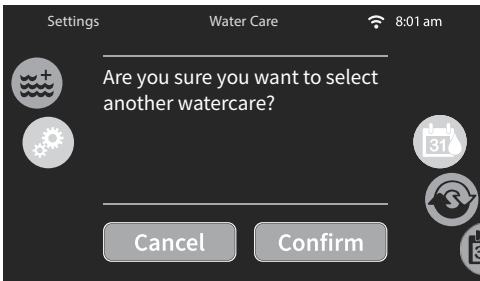

WATER CARE MODIFICATION POP UP SCREEN

Upon selecting a different Water Care mode, a confirmation window will appear to ask you to confirm as means to prevent inadvertent selection given these modes alter how the spa will maintain water temperature and filtering/purge times.

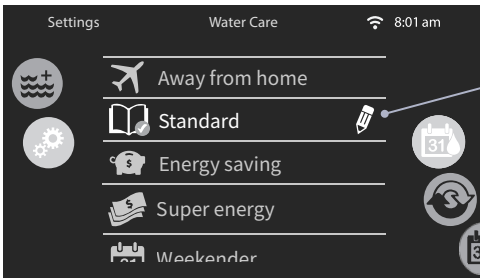

EDITING WATER CARE SETTINGS

To modify a Water Care category, touch the **pencil icon** at the right end of the desired Water Care to open the selected Water Care menu.

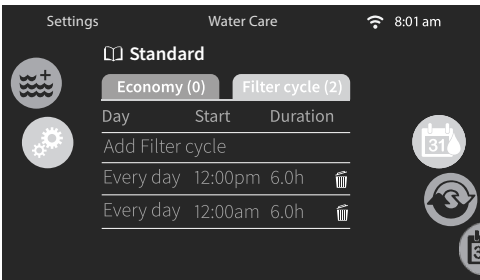

EDITING WATER CARE SETTING DETAILS

Touch the Economy tab to change the economy setting and Filter cycle tab for the filtration settings (or schedules). You can add economy or filtration schedules by touching the orange line labelled "Add Filter cycle" or "Add Economy cycle".

To delete a schedule, touch the garbage can icon at the right end of the desire line. Confirm your action when prompted.

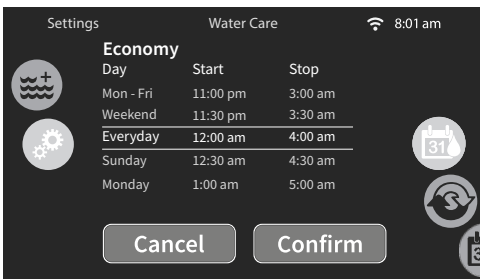

You can modify the programmed schedules by selecting one and adjusting the schedule.

You have several possibilities for the schedule (Mon-Fri, weekend, every day, or single days). The schedules will be repeated every week. The time and duration are set in 30 minute increments. When changes are done, press **"confirm"**. If you don't want to keep any changes, press **"cancel"** or use the calendar icon to go back. Ensure that you have selected the desired Water Care Mode in the main Water Care Menu.

NOTE: If operating the spa during the set filter cycle times, the topside will display the message, "filtering is suspended."

MAINTENANCE

MAINTENANCE

From the Maintenance page  you can access both your Reminders and Standby Mode. To access the desired option simply touch the corresponding menu item.

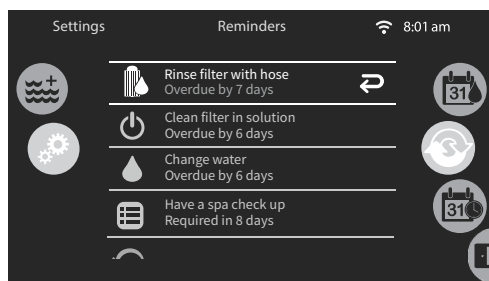
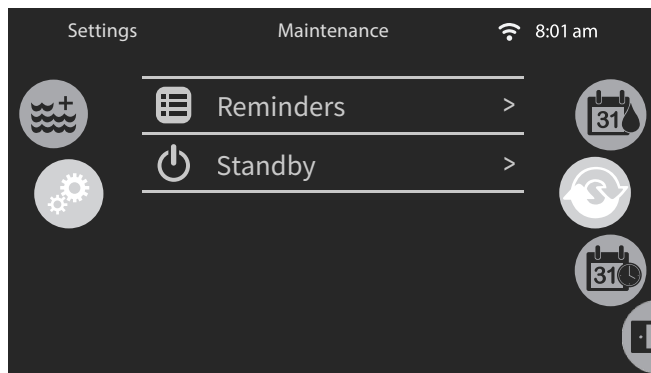

REMINDERS

The keypad will provide reminders about maintenance required on your spa, like rinsing or cleaning the filter. Every task has its own duration based on typical use.

The Reminders menu allows you to check the time left before maintenance is required, as well as to reset the time once a task has been completed.

To reset a task, select it by pressing the curved arrow, then confirm when prompted. Once you have confirmed the task will be reset. You can also use the option *Reset Reminders* to reset all the reminders.

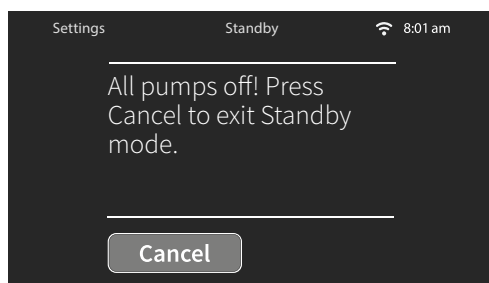

STANDBY

The Standby mode allows you to service your spa (i.e. for changing filters). Pumps will stop for 30 minutes and will automatically restart after. Once exited or time elapses, the normal spa control menu will display and the system will begin operating the pumps normally again.

MAINTENANCE

DATE & TIME

From the Date & Time page  you can change the time and date. Instructions are listed below.

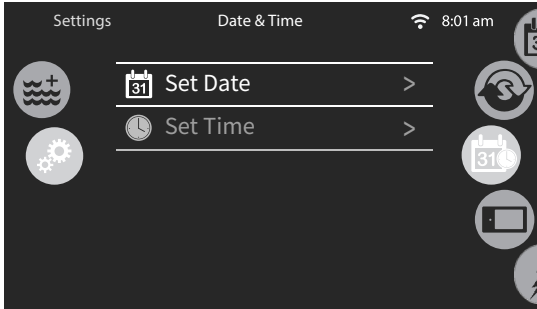

SET DATE

Here you can adjust the year, month and day. Simply swipe up and down the column you want to change and select the desired value. When you are done, touch the calendar icon at the right of the screen.



SET TIME

Here you can change the hour, minute and time format. Simply swipe up and down the column you want to change and select the desired value. When done, touch the calendar icon at the right of the screen.

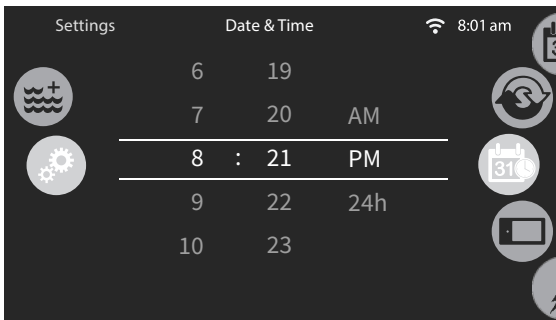

SPA CONTROLS - GECKO in.k1000+

KEYPAD OPTIONS

KEYPAD SETTINGS

Within the keypads page you can access Temperature units, Display, Contrast, Language, Lock spa (optional), *Keypad color* (optional). To select an item, slide the right wheel until the desired icon is highlighted in the middle or press on the menu name.

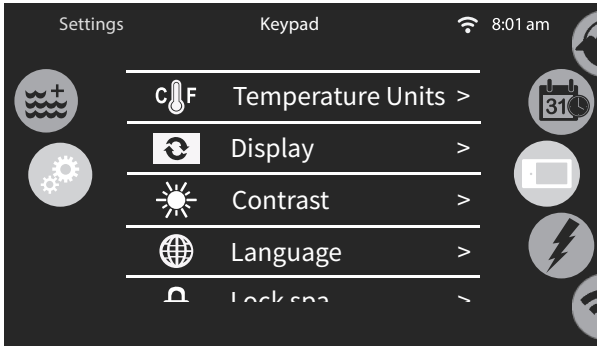

NOTE: Scroll down from this default screen to see Lock spa and Keypad color.

TEMPERATURE UNITS

This allows you to choose the desired units to display the temperature on your spa. You have 2 options: Celsius and Fahrenheit. Simply touching the one you want selects and it goes back to prior menu.



DISPLAY PAGE

Use this page to change the display orientation. By choosing Inverted, the screen orientation will flip 180 degrees opposite of the default setting. This can also be adjusted in the Spa Menu.

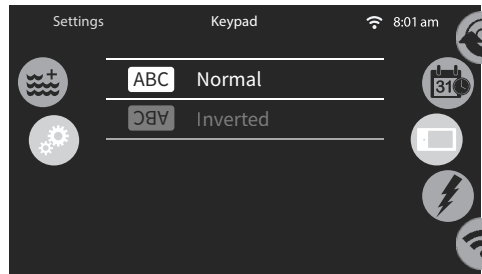

CONTRAST PAGE

Use this page to change the keypad contrast. The Day contrast will keep the screen background darker and the colors more bold to make it easier to use and read in the daylight. The Night contrast lightens the screen background while also desaturating the colors to be easier on your eyes in the evening and at night. This can also be adjusted in the Spa Menu.

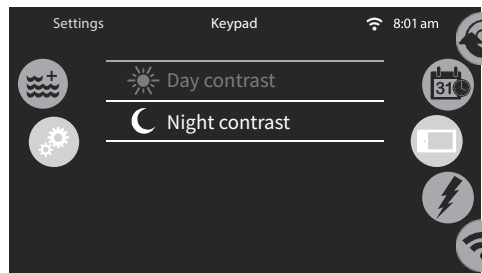

KEYPAD OPTIONS

LANGUAGE SELECT

Use this page to select the display language of the keypad.

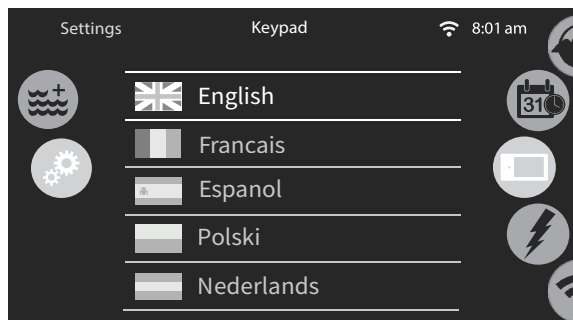

LANGUAGE OPTIONS:

English	Norsk
Français	Svenska
Español	Português
Polski	Italiano
Nederlands	Magyar
Deutsch	Cesky

KEYPAD LOCK/UNLOCK (OPTIONAL)

When this option is enabled, the user can partially or completely lock the keypad. When you want to lock the keypad you will be asked to select a 4-digit code. That same code will be needed to unlock the keypad. Next time you want to lock the keypad, you will be prompted again to select a 4-digit code (same functionality as a Safe in a hotel room). The keypad can be unlocked with a universal unlock code (3732) or by a reset of the keypad.

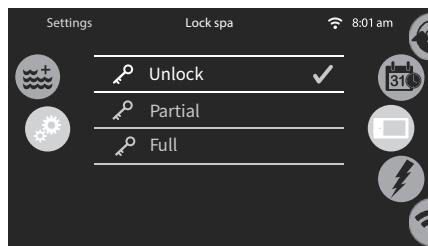

Lock spa screen menu.

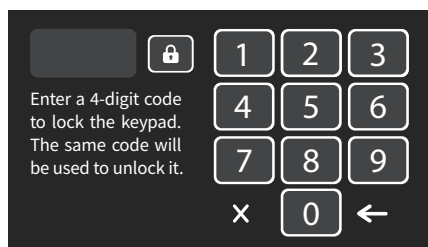

When **Full Lock** is selected, all functions are locked.

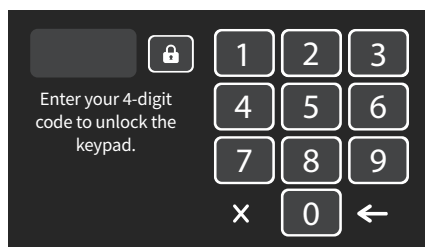

In **Partial Lock**, you may only activate equipment or accessories such as pumps, Settings may not be changed in this mode.

MAINTENANCE

KEYPAD COLOR (OPTIONAL)

If this option is available (depending on the spa configuration), the keypad rim color can be changed. Eight (8) pre-defined colors are available.

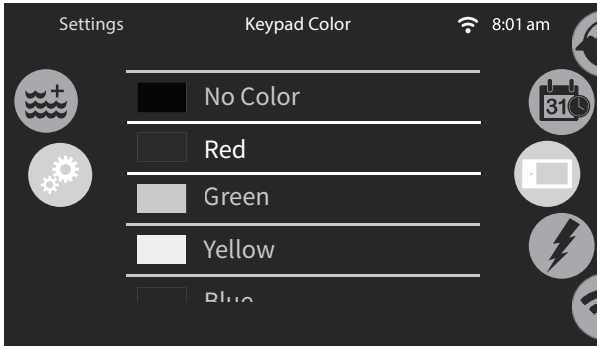

SPA CONTROLS - GECKO in.k1000+

ELECTRICAL CONFIGURATIONS



DO NOT MAKE CHANGES WITHOUT CONSULTING YOUR MASTER SPAS DEALER, AUTHORIZED SERVICE TECHNICIAN AND/OR LICENSED ELECTRICIAN

Changing configurations and electrical settings can result in improper operation, voiding of compliance and/or unsafe electrical draw on your electrical service if not properly configured.

ELECTRICAL CONFIGURATION

In this section, you can change the low-level configuration modify the number of phases, change the input current value. Once the modification is done, hold the Apply button for five seconds. A code may be required to modify these settings. This code is 5555.

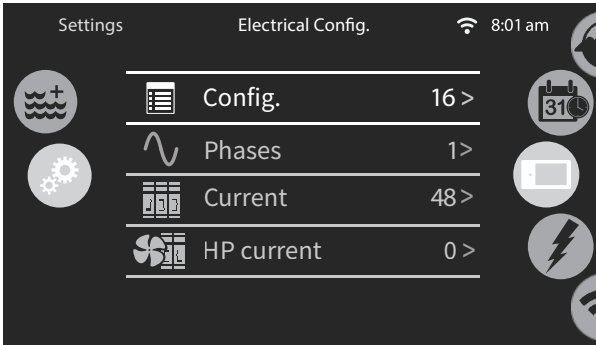

Once a modification is made, you must hold the **Apply** button for five seconds.



After confirmation, the keypad will reset to reconfigure the system. You will be asked to select the custom icons used in the sleep mode. Either one can be selected.

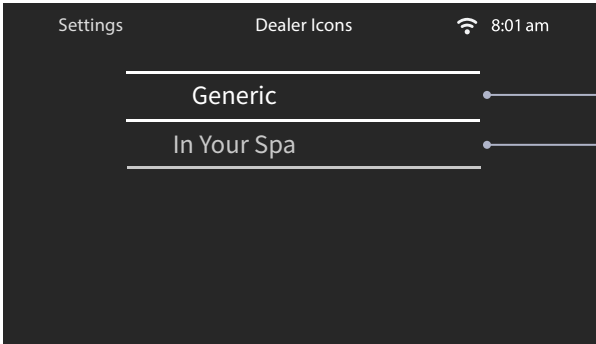

Either one of these options can be selected.

MISCELLANEOUS OPTIONS

MISCELLANEOUS

This menu gives access to modify the Warm Weather option and info messages in the media center.

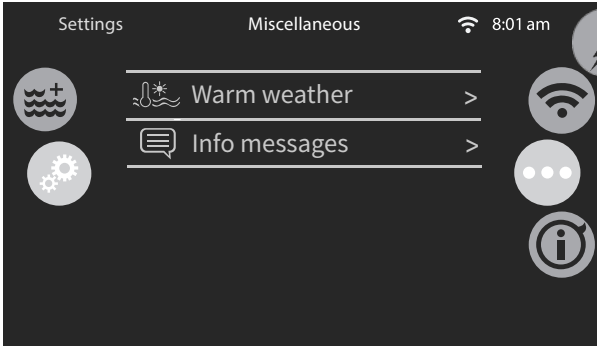

WARM WEATHER

When pumps are running, they produce heat that may increase your water temperature. "Warm Weather" option gives you the ability to bypass the pack filtration over-temperature feature. When Warm Weather is "OFF" the filtration over-temperature is disabled and your spa filtering will continue even if the water temperature is gaining and increasing above the set temperature. Overheat safety protection is not ignored and will engage in the event water temperatures reach unsafe levels.

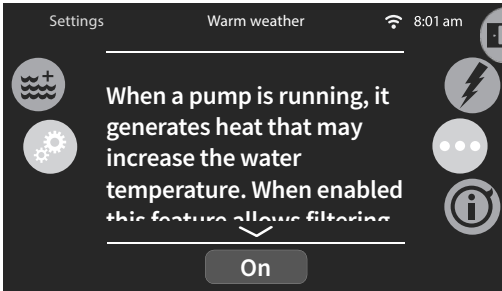

INFO MESSAGES

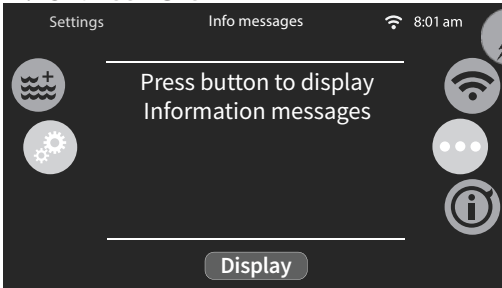

SPA CONTROLS - GECKO in.k1000+

ABOUT

ABOUT

This section show information about the in.k1000+ software number and the revision numbers of the different components of your system.

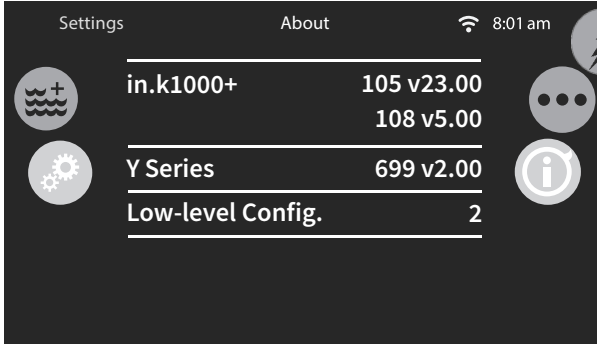

WIPE SCREEN

This message appears when too much water is detected on the touch screen which reduces and is preventing proper touch input recognition. Simply wipe away excess water.

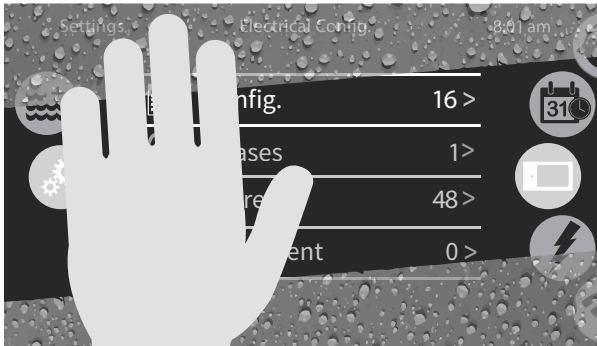

SPA CONTROLS - GECKO in.k1000+

DIAGNOSTIC MESSAGES

The list below shows the different diagnostic messages that can appear on the home screen and a description of each of them. It is important to always check the control panel for messages and verify water temperature before entering the water. Always address and take corrective actions to resolve error message before continued use and entering water.

MESSAGE	DESCRIPTION	ACTION REQUIRED
	No message on display. Display dark. Power has been cut off to the spa.	Check circuit breakers. Turn full off position and back on. If tripping or spa remains off, contact your Master Spas dealer or authorized service center. Licensed electrician may need to be contacted if there is no power to spa though breakers "on".
HL	Heater Flow Loss: There may not be enough water flow through the heater to carry the heat away from the heating element. Heater start up will try again after about 1 min.	Check water level and make sure it is at or above minimum requirement. Make sure pumps are primed and not air locked. Clean filters. Make sure bottom suction are clear and cleaned of any debris. If heating pump is not operating and problem persists, contact your Master Spas dealer or authorized service center.
FLO-L01FLO-L02 FLO	FLO condition - Check filter, pump, blockage, air lock and water level	Check water level and make sure it is at or above minimum requirement. Make sure pumps are primed and not air locked. Clean filters. Make sure bottom suction are clear and cleaned of any debris. If heating pump is not operating and problem persists, contact your Master Spas dealer or authorized service center.
NO FLO	Persistent no flow situation. All equipment has been shut off.	Check water level and make sure it is at or above minimum requirement. Make sure pumps are primed and not air locked. Clean filters. Make sure bottom suction are clear and cleaned of any debris. If heating pump is not operating and problem persists, contact your Master Spas dealer or authorized service center.
HR	A hardware error was detected (Possible stuck relay)	DO NOT ENTER THE WATER. Potentially unsafe conditions present. Contact your Master Spas dealer or authorized service center.
OH	Overheat. The spas water temperature has reached 108°F (42°C).	DO NOT ENTER THE WATER. Check water temperature with digital thermometer. If it is 108°F or higher, remove the spa cover and allow water to cool. Or, add fresh cold water. Once below 107°F/42°C, the spa system can be reset by turning the breaker off and then on again. Check filter cycle durations. Consider reducing durations if reasonable to do so. If error occurs rapidly after power is cycled, contact your Master Spas dealer or authorized service center.
Pr	Temp probes or detection circuit are defective	DO NOT ENTER WATER. Contact your Master Spas dealer or authorized service center.
ROH	Elevated internal temperature	DO NOT ENTER THE WATER. Review and reduce filter cycle durations to reduce equipment runtime. Consider change timing to evenings. Possibly consider additional venting of equipment area if very hot ambient conditions and limited air flow. Consult with your Master Spas dealer or service center.
SP in	Input voltage issue	Wiring to main board needs reviewed as improper power detected. Consult your Master Spas dealer or authorized service technician and a licensed electrician.
Hr	Hardware error was detected (Thermal fuse)	DO NOT ENTER WATER. Contact your Master Spas dealer or authorized service center.
UPL	The spa pack does not have valid software	Contact your Master Spas dealer or authorized service center.
CFLO	No Flow condition	Check water level and make sure it is at or above minimum requirement. Make sure pumps are primed and not air locked. Clean filters. Make sure bottom suction are clear and cleaned of any debris. If heating pump is not operating and problem persists, contact your Master Spas dealer or authorized service center.
Comm	No communication between topside panel and main control board.	Verify cable connections between topside control panel and main control board. Contact your Master Spas dealer or authorized service center.
Supp	Improper power detected.	Wiring to main board needs reviewed as improper power detected. Consult your Master Spas dealer or authorized service center and a licensed electrician.

ENVIRONMENTAL

Operating temperature: -40F (-200C) to 1490F (650C)

Storage temperature: -220F (-300C) to 1850F (850C)

SPA CONTROLS - PUMP DIAGRAMS

MPL 700

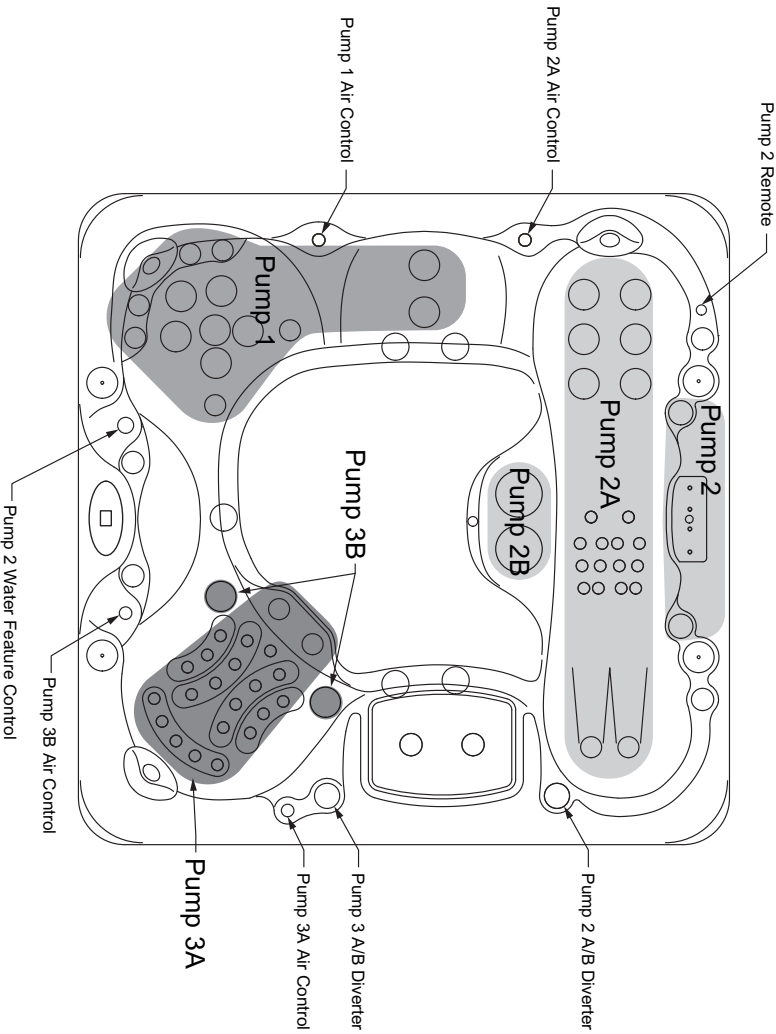

REV 11/2019

SPA CONTROLS - PUMP DIAGRAMS

MPL 800

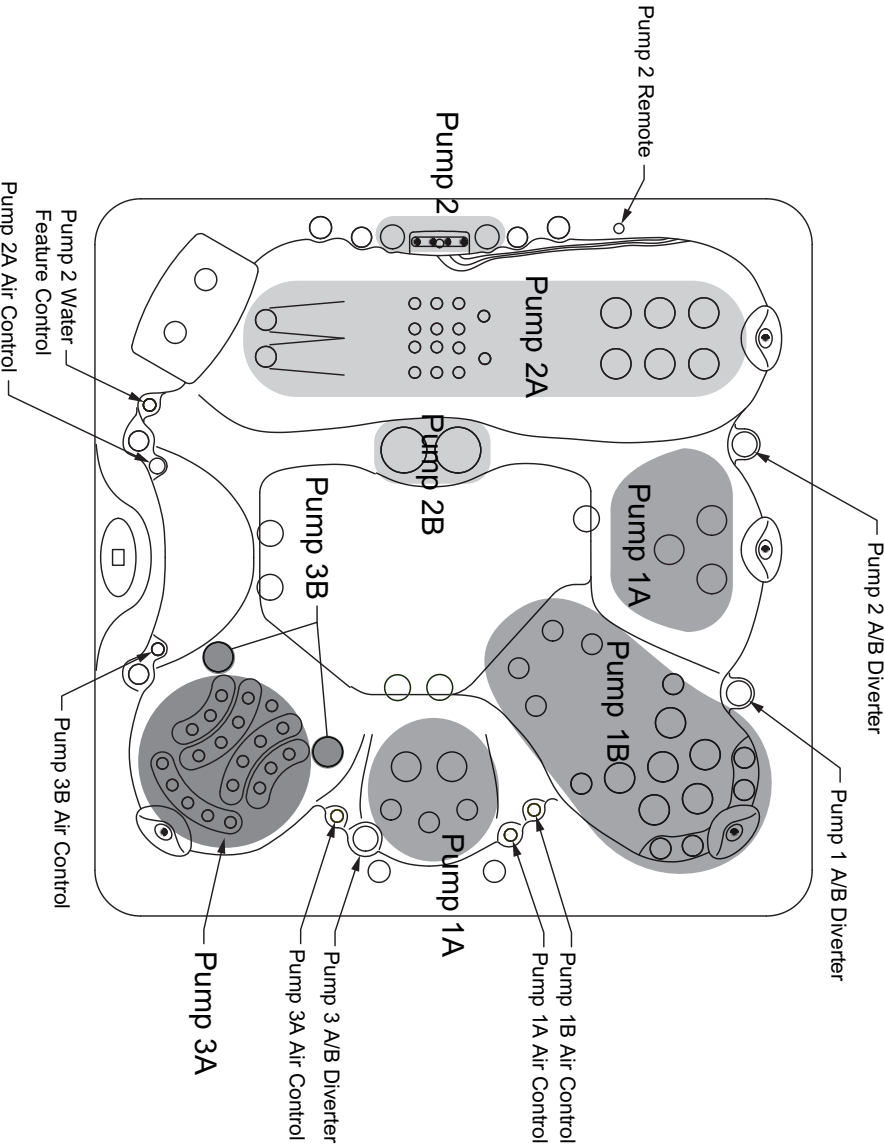

REV/112019

SPA CONTROLS - PUMP DIAGRAMS

MPL 850

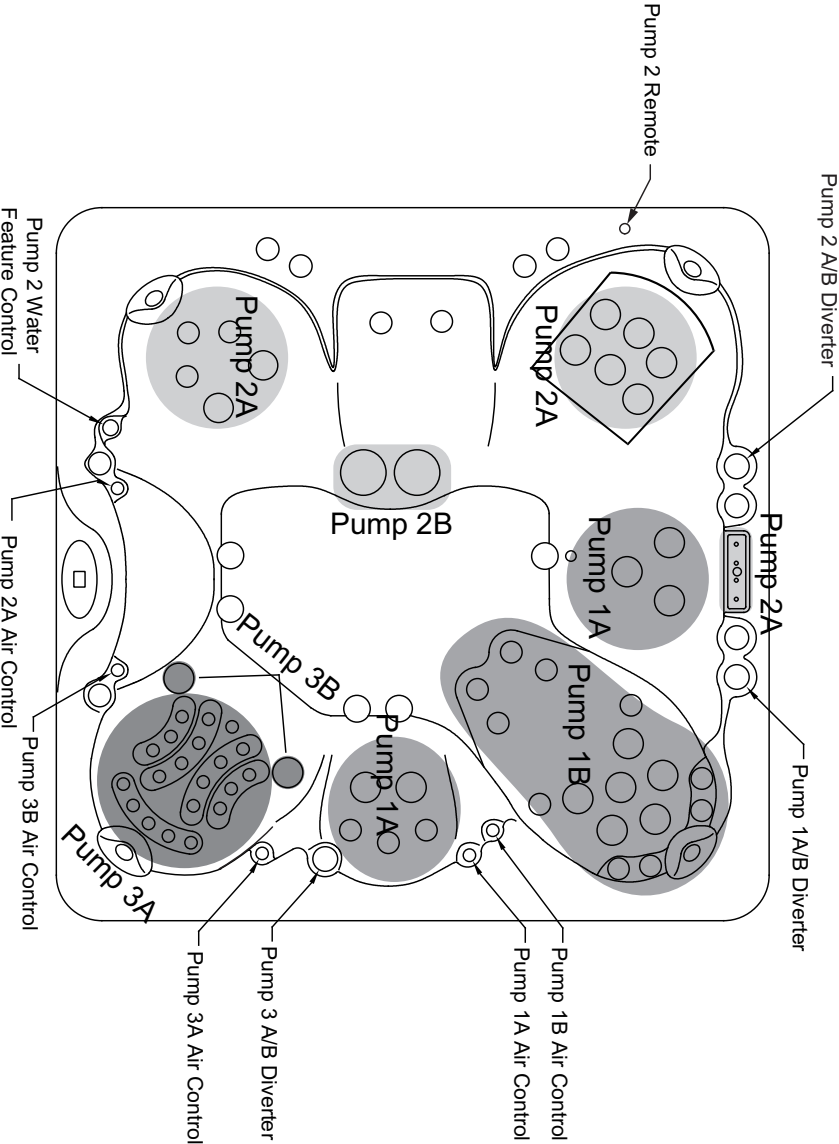

REV. 11/2019

SPA CONTROLS - PUMP DIAGRAMS

MPL 900

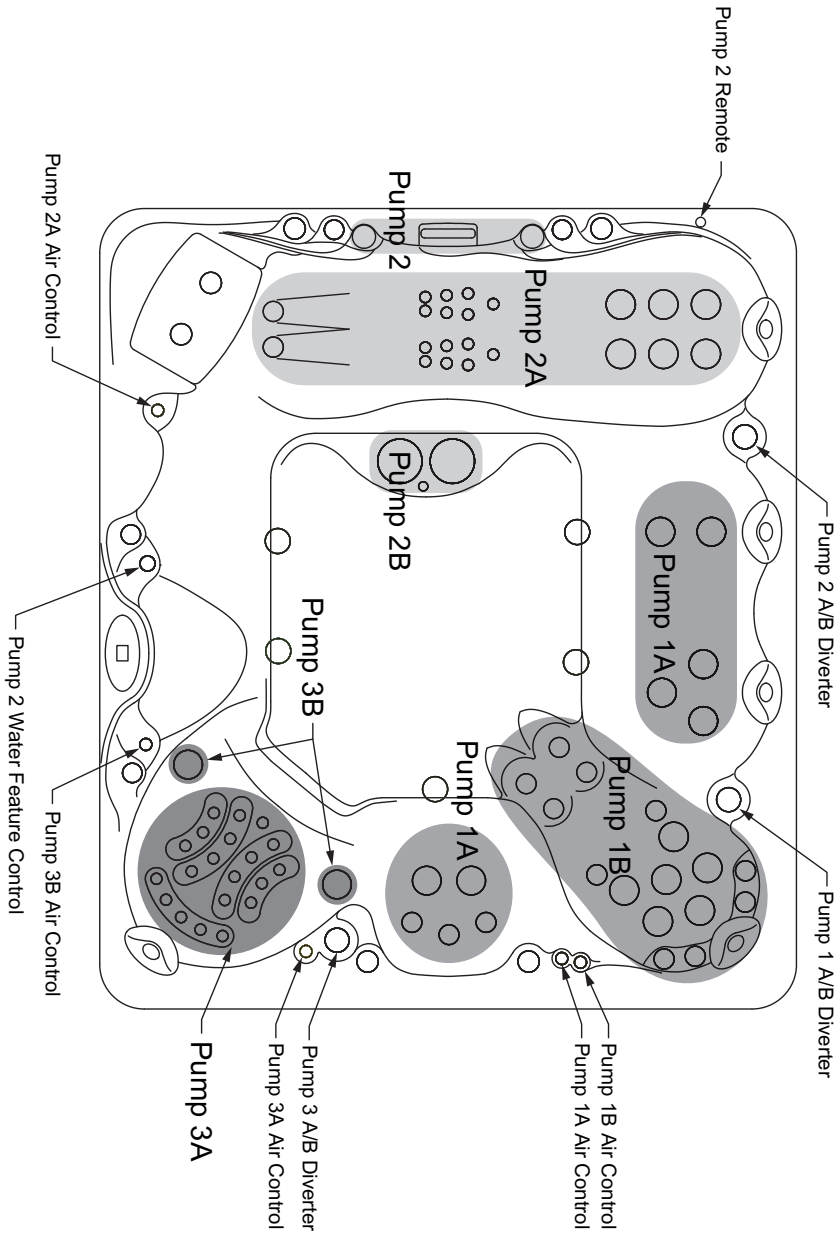

REV 11/2019

MASTER CLEAR SALT SYSTEM "READY" & FACTORY INSTALLED OPTION

The Master Clear Salt System makes maintaining crystal-clear water easier than ever! The system uses a Smart Cell to automatically create chlorine in your spa from highly purified salt that has been dissolved in the water. The salt concentration is much lower than other systems on the market, while still providing the luxurious soaking experience that comes from relaxing in salt water. The Master Clear Salt System allows you to spend more time enjoying your spa and less time maintaining it.

Master Clear Salt System "Ready" (For Simple Activation Kit Installation)

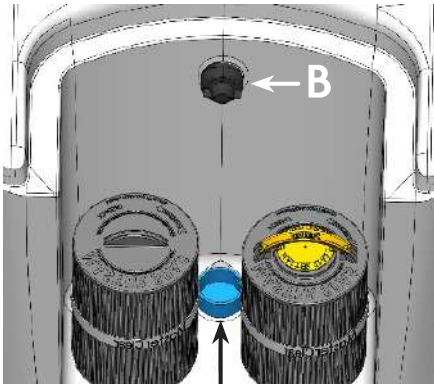

Figure 1

Factory Installed

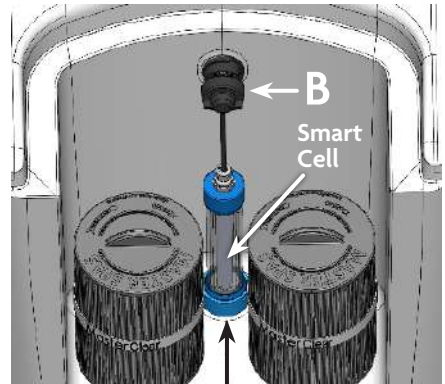

Figure 2

FEATURES:

Items included for both Master Clear Salt System "Ready" and Factory Installed option:

- Smart Cell Base Connection fitting (Figure 1, A) – Located in the bottom of filter housing, this fitting secures the base of the Smart Cell and allows it to twist on/off for easy install, removal and replacement purposes.
- Smart Cell Wall Connection fitting (Figure 1, B) – Located at the top of the filter housing, this electrical connection twists on/off for installation, removal and replacement of the Smart Cell generator. If the spa did not have the Master Clear Salt System option selected when built, then the preinstalled wall fitting includes an 18" wire harness, found inside the equipment cabinet area, to allow the spa to be "Ready" for simple aftermarket Master Clear Salt System Activation Kit installation.

For additional information on Master Clear Salt System, operating instructions, water care and aftermarket installation (Master Clear Salt System "Ready" Activation Kit), scan the QR codes:

Master Clear
Salt System
Overview/Website



Master Clear Salt
System Installation &
Operation Manual



*Master Clear Salt System
Quick Start Guide



*Always review entire Master Clear Salt System Installation & Operation Manual for complete safety instructions and operating guidelines before use. Quick Start Guide is intended for convenient reference to key steps for startup but does not replace the need to review the full installation and operating instructions, for safe and proper use.

MASTER CLEAR SALT SYSTEM "READY" & FACTORY INSTALLED OPTION

Removing or Replacing Smart Cell

1. Twist Smart Cell Wall Connection Fitting (Figure 3, A) counterclockwise to disengage.
2. Twist Smart Cell (Figure 3, B) counterclockwise to disengage and remove.
3. To reinstall Smart Cell, reverse these steps.

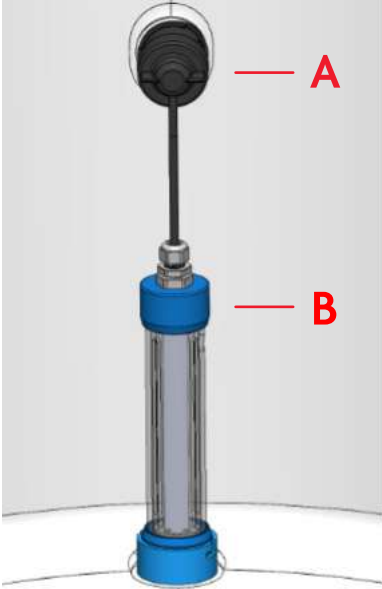
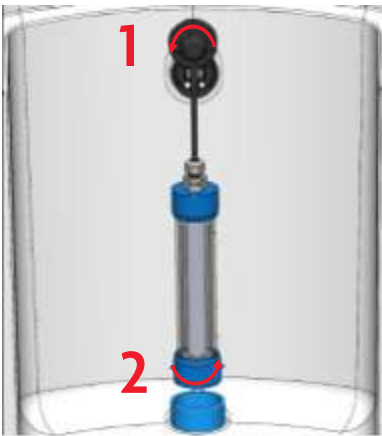
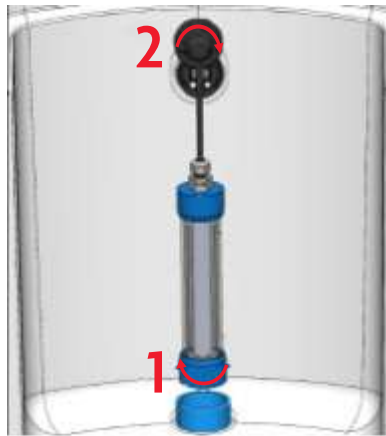

Figure 3



Removing Smart Cell



Connecting Smart Cell

FUSION AIR SOUND SYSTEM (IF EQUIPPED)

REMOTE CONTROL POWER & SYNCING

WARNING – Never remain in your spa longer than 15 minutes per session when the water temperature is above 98°F. If you wish to spend more time in your spa, whether enjoying music, or just lounging, be sure to keep the spa water at or below body temperature (98.6°F).

WARNING – Prevent Electrocutation. Do not connect any auxiliary/external components to the system (i.e. cables, additional speakers, headphones, additional Audio/Video components, etc.).

HANDHELD REMOTE CONTROL CHARGING

The remote has a built-in Polymer Lithium rechargeable battery and comes with a charging cable. Connect one end of the charging cable to the charging connection on remote control and connect the USB end of the charging cable to any USB charger (5V DC) for charging. Be sure charging connection is dry or allowed to dry before connecting to charge.



Make sure the remote has been charged before used. Do not leave remote under spa cover when not in use. Always store remote in dry location when not in use.

HANDHELD REMOTE CONTROL SYNCHRONIZING

The remote should already be paired from the factory, but if you need to synchronize the remote, follow the steps below:

1. Make sure BlueCube+ Media Player is powered ON (red LED).
2. Put the remote within 20 inches (0.5 meter) of the BlueCube+ Media Player.
3. Press and hold  MODE on remote control until the LCD shows “Pairing in Progress”. Release the button.
4. Within 2 seconds, the LCD will show “Paired”. If it fails to pair, the LCD will show “Retry again”. If this happens, wait 5 seconds and repeat steps above.

For any additional remote controls, you will also need to synchronize those remote controls to the BlueCube+ Media Player.

-  If the pairing process is not successful, try again to put your remote close to the remote receiver or charge the remote control if the battery is low.
-  Depending on the frequency of usage, the remote may drain its battery. Please charge the remote before use. If the LCD shows nothing, the battery has been drained and will need charging.
-  If you have lost or damaged your remote control and buy a new remote control, follow the above steps to pair the new remote control.

FUSION AIR SOUND SYSTEM (IF EQUIPPED)

EXPLANATION OF CONTROLS

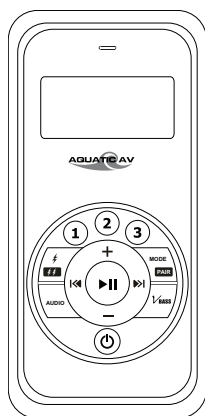

STEREO OUTPUTS

Internal stereo module has capabilities for Bluetooth, FM Radio, AUX and USB. There is no external capabilities for AUX and USB. For this reason, these inputs will not be applicable when seen on remote. Simply use Mode to rotate back to either Bluetooth input or FM.

REMOTE CONTROL

BUTTONS		BLUETOOTH	FM RADIO MODE
Power		Press once: Toggle from Operation mode to Standby mode or vice-versa. Press and hold: No function.	
Mode/Pair		Press once: Change mode. Press and hold: Synchronize remote control.	
Volume Up		Press once: Volume up Press and hold: Fast volume up	
Volume Down		Press once: Volume down Press and hold: Fast volume down	
Fast Forward		Press once: Next track Press and hold: Fast forward	Press once: +0.05kHz Press and hold: Scan up
Fast Rewind		Press once: Previous track Press and hold: Fast rewind	Press once: -0.05kHz Press and hold: Scan down
Play/Pause		Press once: Play/Pause Press and hold: No function	Press once: Toggle mute Press and hold: No function
1		Press once: No function Press and hold: No function	Press once: Listen to FM preset station 1 Press and hold: Set preset FM station 1
2		Press once: No function Press and hold: No function	Press once: Listen to FM preset station 2 Press and hold: Set preset FM station 2
3		Press once: No function Press and hold: No function	Press once: Listen to FM preset station 3 Press and hold: Set preset FM station 3
EXT Trigger		Press once: No function Press and hold: No function	Press once: No function Press and hold: No function
Audio		Press once: Enter Audio Menu Press and hold: Save & Exit Audio Menu	
VBass		Press once: Toggle VBass on/off Press and hold: No function	

FUSION AIR SOUND SYSTEM (IF EQUIPPED)

LISTENING TO DEVICES

PAIR WITH BLUETOOTH DEVICE

1. Switch on your Bluetooth device.
2. Select 'AQUATIC AV' from the list of available devices to pair (no password is needed).

LISTENING VIA BLUETOOTH DEVICE

1. Bluetooth mode will be activated once a Bluetooth device is paired in any mode. Use **MODE** **PAIR** (MODE) to change to the Bluetooth mode to listen to music.
2. Play the song from device and the sound will play through the BlueCube+ Media Player.
3. Press **▶||** (PLAY/PAUSE) to play/pause the song.
4. Press **◀◀** / **▶▶** (FAST REWIND/FAST FORWARD) buttons to play previous/next song file.
5. Press and hold **◀◀** / **▶▶** (FAST REWIND/FAST FORWARD) buttons to fast forward/fast rewind the song file.
6. Previous/next track and volume up/down can be controlled directly from your Bluetooth device or directly from the BlueCube+ Media Player remote control.

BLUETOOTH MULTI-LINK

A second Bluetooth device can pair to the BlueCube+ Media Player even when it has been paired to another Bluetooth device. The second Bluetooth device will be able to play once the first device has stopped playing.



ADJUST VOLUME LEVEL

1. Press **+** (VOLUME UP) once to increase the volume.
2. Press **-** (VOLUME DOWN) once to reduce the volume.
3. Press and hold either **+** or **-** (VOLUME UP or VOLUME DOWN) to increase or decrease audio volume continuously.

FUSION AIR SOUND SYSTEM (IF EQUIPPED)

LISTENING TO DEVICES





ENTER FM RADIO MODE

1. Press  (MODE) on the remote control to switch to FM radio mode.
2. Press  (PLAY/PAUSE) to mute or unmute the audio.



 If this is the first time you listen to FM radio, the default frequency will be 87.5MHz, as shown on the remote LCD.

 FM radio is only available when you are in FM Radio mode. Scan or seek FM radio Channels.

SCAN OR SEEK FM RADIO CHANNELS

1. Press  /  (FAST REWIND/FAST FORWARD) to seek another station.
2. Press once  /  (FAST REWIND/FAST FORWARD) to -0.05kHz or +0.05kHz to the frequency.





SAVING RADIO CHANNEL TO MEMORY

To save the current frequency to memory, press and hold the   or  for more than 2 seconds. The station will be stored into relevant button.

LISTENING TO SAVED RADIO MEMORY

Press the   or  preset button once to listen to the station stored in that button.

ADJUST VOLUME LEVEL

1. Press  (VOLUME UP) once to increase the volume.
2. Press  (VOLUME DOWN) once to reduce the volume.
3. Press and hold either  or  (VOLUME UP or VOLUME DOWN) to increase or decrease audio volume continuously.

FUSION AIR SOUND SYSTEM (IF EQUIPPED)

ADDITIONAL FEATURES

AUDIO MENU

The BlueCube+ Media Player is equipped with an audio DSP (Digital Signal Processor) to provide preset listening experiences for different music types.

1. To enter audio menu, press **AUDIO** (AUDIO) button once on the remote control.

2. Each press of **AUDIO** (AUDIO) button will advance to the next audio setting as described on the right.

3. In the audio menu, press and hold **AUDIO** (AUDIO) to save and exit the audio menu back to the original mode.

If you have chosen preset equalizer (Rock, Classic, or Pop), the previous Bass & Treble settings will be overridden.

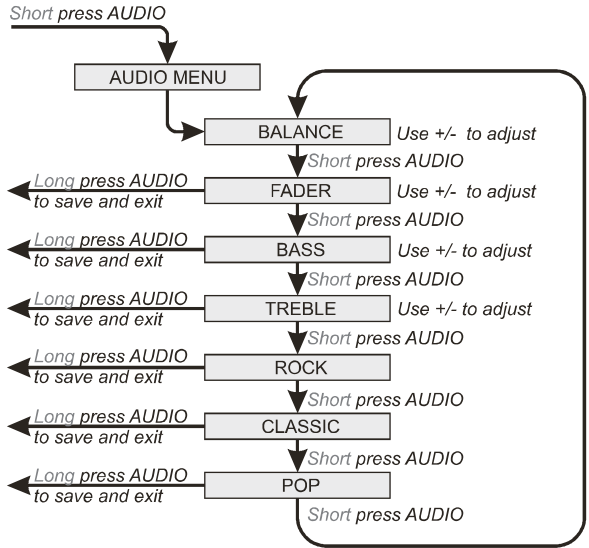

VIRTUAL BASS (VBASS)

Virtual Bass (VBass) boosts the bass of the audio signal using the latest DSP technology and is particularly useful when used with very small speakers to create perceived bass frequencies of a much larger speaker.

Press **VBASS** (VBASS) once on the remote control to toggle it on or off.

GECKO in.touch 2 WIFI

GECKO WIFI

WI-FI SET UP

The in.touch 2, used to connect your spa to the Internet, transforms your iOS or Android smartphone or tablet into your ultimate mobile remote control. The in.touch 2 comes with 2 pre-paired radio frequency transmitters, one being part of your spa system and the second one being connected to your Internet router. Please refer to the installation documents listed below to help set up your Wi-Fi controller.

The Wi-Fi included is a two piece module. One piece comes already installed on your spa. The second is packaged in the equipment area. Connect this piece to your home Wi-Fi router and plug it into the wall to allow connection between your spa and your home Wi-Fi Router.



Luggage Pack Location



in.touch 2 Home Router Receive

TEXT:

Gecko Teckbook

<https://www.geckodocs.com/wireless>

in.touch2 techbook

http://issuu.com/geckomkt/docs/touch2_techbook_en?e=14165552/41946535

Use the in.touch2 Gecko app on your mobile device to continue set up with Gecko and control your swim spa.

NOTE: WiFi Module is not available for all spa models. If this option was not added from the factory, see your Master Spas dealer for further details and compatibility. If your spa was equipped from the factory with WiFi option, the spa control module will be connected to the control system and mounted inside the equipment area to the spa frame. The Gecko WiFi box with home module components will be included in the spa luggage bag with your spa owner's manual.

CABINET LIGHTING

The Cabinet Lighting is a standard feature adding streams of light to accent the main skirting panels of your hot tub at night. This low-energy LED lighting system is controlled by a photo cell located on the front side with the Master Spas logo. The Master Spas logo always stays on as a power indicator while the lighting streams turn on during lower lighting conditions, such as dusk to dawn, or shuts off during bright, sunny days.



Note: This regular maintenance for the Mast3rPur™ system is not covered under the warranty of the spa. Your Master Spas dealer or service organization can be contacted to schedule this maintenance.

WARNING – BEFORE PERFORMING ANY MAINTENANCE ON THE MAST3RPUR™ SYSTEM, MAKE SURE THE SPA IS SHUT DOWN.

Your Mast3rPur UV/Ozone system will require the following regular maintenance to allow continued, optimal operation.

- Quartz Tube (15) should be cleaned every six months of usage.
- UV-C Lamp (20) - needs replaced every 12 months of usage (during a drain and refill maintenance point falling between this time frame).
- Ozone Cell (5) - needs replaced every 12-18 months, during a spa drain and refill.

NOTE: Please contact your Master Spas Dealer or service organization to perform this maintenance for you.

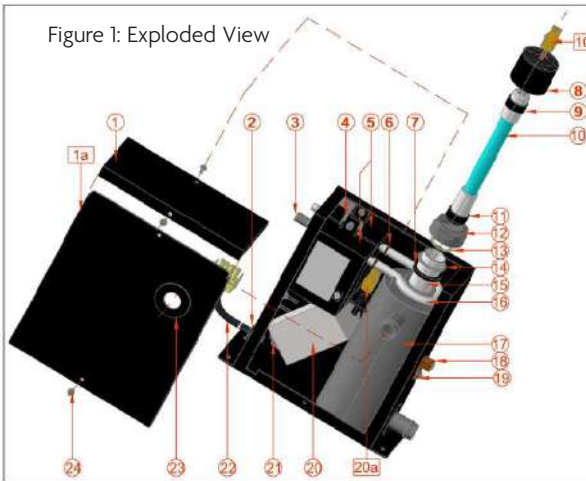

KEY	DESCRIPTION
1	ENCLOSURE TOP COVER
1a	ENCLOSURE FRONT COVER
2	STRAIN RELIEF
3*	AIR FILTER
4**	BRACKET: DUAL OZONE CELL
5***	OZONE CELL
6**	OZONE HOSE CLAMP
7	QUARTZ SEAL GASKET
8	BOOT COVER
9	UPPER CUSHION
10	UV LAMP
10a	LAMP CONNECTOR
11	LOWER CUSHION
12	COMPRESSION NUT
13	PLASTIC WASHER
14	COMPRESSION WASHER
15	QUARTZ TUBE
16**	OZONE CONNECTION HOSE
17	REACTION CHAMBER
18	GROUND LUG
19	HEX NUT
20	ELECTRONIC BALLAST
20a	BALLAST CONNECTOR
21	8 - 32x1/4" SCREW
22	POWER CORD
23	RUBBER WASHER
24	8 - 32x 5/16" SCREW

*Item 3 as shown is for 2 ozone cells models.
 **Item 4, 6, 16 are for models with 2 ozone cells only.
 ***Item 5 as shown is for 2 ozone cell models

QUARTZ TUBE (6) CLEANING INSTRUCTIONS

DANGER – Turn the spa breaker to OFF position.

- Open the spa controller's cover and disconnect the unit from the spa controller.
- Drain the spa.

WARNING – Allow UV-C lamp (10) to cool down prior to removing from the unit.

DANGER – Never look at the lit UV-C lamp (10). This can cause severe eye damage or blindness.

- Remove water hoses from the unit as well as water inlet/outlet barbs and drain water out of the unit completely. Fold the water hoses and secure with clamp locking pliers to stop water from running out from the spa before removing them from the unit.
- Remove enclosure top cover (1) from the unit.
- Make sure to use latex glove when handling the UV-C lamp (10).

MAST3RPUR™ (IF EQUIPPED)

- F. Disconnect UV-C lamp connector (10a) from ballast connector (20a).
- G. Slowly remove UV-C lamp (10) from quartz tube (15).
- H. Remove quartz seal compression nut (12).
- I. Use bare hands carefully to remove quartz seal gasket (7) and metal compression washer (14) that go over the quartz tube. Do not use any metal tools.
- J. Carefully remove the quartz tube (15).

WARNING – Be very careful when handling broken glass to avoid injury, and wipe off any spilled water inside the unit.

- K. Clean the quartz tube (15) with paper towel or dry cotton cloth. Do not use abrasive cleaner as that can scratch the quartz tube surface. Household tub and shower lime removal products can be used if needed. Rinse the quartz tube (15) with clean water to completely remove any cleaning products that were used.
- L. Install the quartz seal gasket (7) over the opened end of the new quartz tube (15). Place the new quartz tube (15) into the unit with the domed end first making sure it is inserted and seated inside the quartz end holder on the bottom of the reaction chamber. Only about 1/8" of quartz tube (15) will be exposed when it is seated correctly.
- M. Reinstall the compression washer (14) over the open end of the quartz tube (15). Push it against the quartz seal gasket (7).
- N. Reinstall and hand tighten the quartz seal compression nut (12) by turning it clockwise until it stops. Add another quarter of a turn by using a pair of Channel Lock pliers.
- O. Securely re-connect water hoses to the unit water inlet and outlet bars.
- P. Fill the spa. Make sure no water is dripping from the seal compression nut (12). If water is visible, STOP and tighten the compression nut another quarter of a turn with a pair of Channel Lock pliers to make sure it's completely sealed. Make sure there is no water leaking anywhere before proceeding to the next step.
- Q. Turn the breaker back on. Turn on the pump to circulate the water through the unit. Wait for 5 minutes and assure no water is dripping. If water is visible, STOP, fix the leak by repeating the quartz tube maintenance process from step (a) to step (o). Ensure no water dripping from the seal compression nut (12) or water inside quartz tube (15) before proceeding to next step.
- R. Turn the pump OFF, then turn the breaker OFF before proceeding to the next step.
- S. Slide the UV-C lamp (10) back inside the quartz tube (15).
- T. Reconnect the UV-C lamp connector (10a) to the ballast connector (20a). Make sure the connectors mate completely. Do not use force. Line up the locking tabs on connector (10a) with connector (10b).
- U. Reinstall the enclosure top cover (1) then secure with screws removed previously.
- V. Reconnect the water hoses back to the unit & secure with clamps.
- W. Reconnect the unit to the spa controller and reinstall the spa controller's cover.
- X. Turn ON the power to the spa.
- Y. Once power is activated you can check the LEDs to see if the unit is functioning. A solid green light indicates the unit is being provided power and should always be on. A solid blue light indicates that UV-C lamp is activated.

MAST3RPUR™ (IF EQUIPPED)

NOTE: Only use a proper replacement UV-C lamp (10), which can be acquired through your Master Spas Dealer or service organization.

UV-C LAMP (10) REPLACEMENT INSTRUCTIONS

DANGER – Turn the spa breaker to OFF position.

- A. Open the spa controller's cover and disconnect the unit from the spa controller.

WARNING – Allow UV-C lamp (10) to cool down prior to removing from the unit.

Danger – Never look at the lit UV-C lamp (10). This can cause severe eye damage or blindness.

- B. Drain the spa.
- C. Remove water out of the Mast3rPur unit completely.
- D. Remove enclosure top cover (1).
- E. Make sure to use latex gloves when handling the UV-C lamp (10).
- F. Slowly disconnect the old UV-C lamp connector (10a) from ballast connector (20a).
- G. Slowly remove old UV-C lamp (10) from quartz tube (15). Save the upper cushion (9) and lower cushion (11).
- H. Install the upper cushion (9) and lower cushion (11) to the NEW UV-C lamp (10).
- I. Slide the NEW UV-C lamp (10) into the quartz tube (15).
- J. Reconnect the NEW UV-C lamp connector (10a) to the ballast connector (20a). Make sure the connectors mate completely. Do not use force. Line up locking tabs on connector (10a) to connector (20a).
- K. Reinstall the enclosure top cover (1) and secure with the screws removed previously.
- L. Reconnect the unit to the spa controller and reinstall the spa controller's cover.
- M. Turn ON the power to the spa.
- N. Once power is activated you can check the LEDs to see if the unit is functioning. A solid green light indicates the unit is being provided power and should always be on. A solid blue light indicates that UV-C lamp is activated.

WARNING – The UV-C lamp used in this unit contains mercury. Properly dispose the old UV-C lamp in accordance with disposal laws. See www.lamprecycle.org.

LIMITED WARRANTY

MICHAEL PHELPS LEGEND SERIES



Note: This Limited Warranty applies to residential use within the United States and Canada.

10 YEARS - SPA STRUCTURE

Master Spas warrants to the original retail purchaser the structural integrity of the spa against water loss from the spa due to defects in material or workmanship, in the spa structure for a period of 10 years from the date of the original retail purchase. Master Spas will either repair, including the parts and labor to repair the spa structure, or replace the nonconforming Spa Structure. In the event of replacement, the cost of labor and equipment for removal and replacement of the unit is the sole responsibility of the Purchaser.

7 YEARS - SHELL SURFACE

Master Spas warrants to the original retail purchaser that the acrylic finish will not blister, crack or delaminate for a period of 7 years from the date of original retail purchase as a result of defects in material or workmanship. Master Spas will either repair, including the parts and labor to repair the shell surface, or replace the nonconforming shell. In the event of replacement, the cost of labor and equipment for removal and replacement of the unit is the sole responsibility of the Purchaser. There is no Shell Surface Warranty on blemished units.

5 YEARS - EQUIPMENT

Master Spas warrants to the original retail purchaser the spa equipment (pumps, heater and control system) should a component of the Equipment Pack fail or malfunction due to defects in material and workmanship, for a period of 5 years from the date of the original retail purchase. Master Spas will either repair or replace the applicable component, including replacement parts and labor to install them (parts and labor).

5 YEARS - PLUMBING

Master Spas warrants to the original retail purchaser for a period of 5 years from the date of original retail purchase that the plumbing of the spa will not leak due to defects in material and workmanship (Master Spas will provide replacement parts and labor to repair or replace the applicable components).

5 YEARS - JETS

Jet internals are warranted against malfunctions due to defects in material for a period of 5 years from the date of original retail purchase (Master Spas will provide replacement jet internal parts only). The cost of shipping and installation of any jet internals is the sole responsibility of the purchaser. After initial delivery and startup, discoloring or fading of the plastics, corrosion of any stainless steel components and sticking/seizing of the adjustable jet internals or their spinning nozzles are specifically excluded from these warranty terms.

5 YEARS/LIFETIME - SKIRTING* (DreamStone™)

Master Spas warrants to the original retail purchaser that the optional DreamStone™ skirting will not crack or rip due to defects in material for a period of 5 years from the date of the original retail purchase. Master Spas warrants to the original retail purchaser only that the DuraMaster Polymer™ skirting will not crack or rip for the life of the spa. Bowing that can occur under some conditions is considered normal and excluded by this limited warranty. Normal wear and weathering that occur overtime are not defects. If the skirting on the spa fails due to defects in materials or workmanship, Master Spas will replace the applicable skirting components (parts only). The cost of shipping and installation of any replacement skirting is the sole responsibility of purchaser.

2 YEARS PARTS/1 YEAR LABOR - LED LIGHT SYSTEM*

Master Spas warrants to the original retail purchaser, for a period of 2 years from the date of original retail purchase that the optional, factory installed LED light system will not malfunction

*If equipped. Options vary by model.

LIMITED WARRANTY

MICHAEL PHELPS LEGEND SERIES



Note: This Limited Warranty applies to residential use within the United States and Canada.

due to defects in workmanship and materials (parts). If the LED light system or any component there of fails due to defects in material or workmanship, Master Spas will either repair or replace the applicable components. This limited warranty on LED light systems covers the labor for a period of 1 year from the date of retail purchase. After 1 year, the purchaser is solely responsible for any labor costs associated with the repair or replacement of an applicable component.

1 YEAR - CABINET LIGHT

Master Spas warrants to the original retail purchaser, for a period of 1 year from the date of original retail purchase, that the, factory installed Cabinet Light system in the spa skirt will not malfunction due to defects in workmanship and materials. If the Cabinet Light system or any of its components thereof has malfunctioned due to defects in workmanship or materials, Master Spas will either repair or replace the applicable components of the Cabinet Light system (parts and labor).

1 YEAR - OZONATOR*

Master Spas warrants to the original retail purchaser that the factory installed ozonator will not malfunction due to defects in materials or workmanship for a period of 1 year from the date of original retail purchase. If the ozonator malfunctions due to a defect in materials or workmanship, Master Spas will either repair or replace the applicable components including parts and labor.

1 YEAR - MAST3RPUR SYSTEM*

Master Spas warrants to the original retail purchaser that the factory installed Mast3rPur system will not malfunction due to defects in materials or workmanship for a period of 1 year from the date of original retail purchase. If the Mast3rPur system malfunctions due to a defect in materials or workmanship, Master Spas will either repair or replace the applicable components including parts and labor.

1 YEAR - MASTER CLEAR SALT SYSTEM*

Master Spas warrants to the original retail purchaser that the factory installed Master Clear Salt System (main controller and factory installed harnesses) will not malfunction due to defects in materials or workmanship for a period of 1 year from the date of original retail purchase. If the Master Clear Salt System were to malfunction due to a defect in materials or workmanship, Master Spas will repair or replace the applicable components including parts and labor. The replaceable, consumable Smart Cell generator for the Master Clear Salt System is excluded from this limited warranty. If the salt system Smart Cell generator malfunctions within 90 days from the date of original purchase due to a defect in materials or workmanship, Master Spas will repair or replace the Smart Cell generator (parts only).

1 YEAR/90 DAYS - AUDIO EQUIPMENT*

Master Spas warrants to the original retail purchaser, the optional stereo and enclosure components within the audio system against malfunctions due to defects in material and workmanship for a period of 1 year (parts). This limited warranty on all optional Audio Equipment covers labor for a period of 90 days from the date of original retail purchase. After 90 days, the purchaser is solely responsible for any labor costs associated with the repair or replacement of any applicable audio components. Master Spas shall not be responsible for any damages or losses to any accessories (not supplied by Master Spas), including but not limited to iPods or similar systems, caused by a defect or malfunction of any Master Spas supplied component.

*If equipped. Options vary by model.
DO NOT DIVE.

LIMITED WARRANTY

EXCLUSIONS AND LIMITATIONS

EXCLUSIONS

This limited warranty is enforceable only by the original retail purchaser from the date of original retail purchase but is voidable if the entire purchase price has not been paid to the retail dealer. Light bulbs, light lenses, fuses, overlays/labels, covers, spa pillows or any dealer installed accessories are specifically excluded from this limited warranty. All warranties are void if the spa is placed in commercial service. Any spa in service at a residential rental property, the warranty periods are reduced as follows: any warranty period of 4 years or more, are reduced to 2 years; any warranty period of 2 to 3 years, are reduced to 1 year; any warranty periods of 1 year or less, remain the same. Normal wear and weathering of finishes and components are not defects and specifically excluded from this limited warranty. In the event it is necessary to remove the spa from the residential premises to repair or replace any warrantable item, any and all cost of spa removal and replacement including but not limited to removal of the original spa and transportation of the replacement spa, damages to landscaping, decking, fencing or other structural alteration, or any cost related to obtaining access to the spa are the sole responsibility of the purchaser. Spa covers are not included or covered by this spa warranty.

LIMITATIONS

This limited warranty is voidable if the spa has been subject to misuse, alteration or attempted alteration, repairs or attempted repairs by a non-approved service center or if a failure or malfunction is due to improper installation, improper water chemistry, improper maintenance or lack of normal maintenance as prescribed in the Master Spas Owner's Manual, an act of God, weather conditions, animals, rodents, pests or any damage from causes beyond the control of Master Spas. Misuse or abuse shall mean operation of the spa other than in conformity with the Master Spas Owner's Manual. Such misuse and abuse shall include but not be limited to the following:

- Damage of the spa surface and components caused by leaving the spa uncovered or due to covering the spa with plastic film of any kind.
- Damage to the spa surface and components caused by use of a non-insulating cover or an unapproved cover not manufactured by Master Spas when the spa is subject to weather conditions and sun.
- Damage to the spa surface and components caused by contact with unapproved cleaners or solvents.
- Damage caused by operation of the spa at water temperatures outside the range of 34° F -104° F.
- Freeze damage.
- Damage caused by unapproved sanitizers such as calcium hypochlorite, sodium hydroxide, "tri-chlor" type chlorines or any sanitizing chemical that may remain undissolved on the spa surface.
- Damages or malfunction due to a dirty, clogged, calcified filters or use of an unapproved filter cartridge.
- Damages or malfunction caused by failure to provide even, proper support for the spa.
- Damages or malfunction caused during installation of the spa.
- Damages or malfunction caused by use of unapproved filter cartridges.

LIMITED WARRANTY

EXCLUSIONS AND LIMITATIONS

WARRANTY REGISTRATION AND WARRANTY CLAIM PROCEDURE

The original retail purchaser should register their spa purchase within 10 days from the date of original retail purchase to establish proof of purchase with Master Spas. Failure to register does not void this limited warranty but, upon any warranty claim, proof of purchase must first be provided to confirm original retail purchase date to the original retail purchaser. Spa Registration can be submitted online at www.masterspas.com/resources. In the event of a warranty claim of a defect or malfunction covered under the provisions of this limited warranty, the original retail purchaser must first notify in writing the retail dealer who sold the spa within ten (10) days of the initial malfunction or discovery of defect. If the retail dealer does not provide service, then the purchaser should contact Master Spas customer service department, via the website, or provide written notice of the malfunction or defect at the address below. Upon notice of the warranty claim, the retail dealer or an approved independent service center representative will arrange inspection of the spa with the retail purchaser to determine if the claimed malfunction or defect is a covered malfunction or defect under this limited warranty. If it is determined that the malfunction is not covered by this limited warranty, the cost of the service call is the sole responsibility of the purchaser. If it is determined that the malfunction or defect is covered under this limited warranty, Master Spas through the retail dealer, or approved independent service center will repair or replace the covered item. In the event of spa replacement, the replacement spa will carry the balance of the original spa warranty from the original retail purchase date. Master Spas reserves the right for its dealers or approved service centers to collect from the retail purchaser reasonable travel expenses. In addition, access charges will be assessed if the spa is not reasonably accessible for inspection, repair or replacement. This limited warranty is extended only to the original retail purchaser and is not transferable. This limited warranty becomes void upon the transfer of ownership of the spa or moving of the spa to a different location.

DISCLAIMERS

MASTER SPAS LLC, NEITHER ASSUMES NOR DO WE AUTHORIZE ANY OTHER PERSON TO ASSUME FOR US, ANY OTHER LIABILITY IN CONNECTION WITH THE SALE OF SPAS MANUFACTURED BY MASTER SPAS. THIS LIMITED WARRANTY SHALL BE THE EXCLUSIVE REMEDY AVAILABLE TO A PURCHASER AND MASTER SPAS SHALL NOT BE LIABLE FOR ANY INCIDENTAL OR CONSEQUENTIAL DAMAGES RESULTING FROM MISUSE OF THE SPA OR CAUSED BY ANY DEFECT, FAILURE OR MALFUNCTION OF THE SPA, WHETHER A CLAIM IS BASED UPON WARRANTY, CONTRACT, NEGLIGENCE OR OTHERWISE. SOME STATES DO NOT ALLOW THE EXCLUSION OF INCIDENTAL OR CONSEQUENTIAL DAMAGES, SO THIS LIMITATION MAY NOT APPLY TO YOU.

TO THE EXTENT PERMITTED BY APPLICABLE LAW, THIS LIMITED WARRANTY SPECIFICALLY EXCLUDES ANY AND ALL IMPLIED WARRANTIES OF MERCHANTABILITY AND/OR FITNESS FOR A PARTICULAR PURPOSE, OTHERWISE ALL IMPLIED WARRANTIES ARE LIMITED IN DURATION TO TWO (2) YEARS FROM THE ORIGINAL DATE OF RETAIL PURCHASE. SOME STATES DO NOT ALLOW THE LIMITATION OF THE DURATION OF IMPLIED WARRANTIES, SO THIS LIMITATION MAY NOT APPLY TO YOU. THERE ARE NO OTHER WARRANTIES, EITHER EXPRESSED OR IMPLIED, OF ANY KIND OR NATURE WHICH EXTEND BEYOND THE DESCRIPTION ON THE FACE HEREOF. SOME STATES DO NOT ALLOW THE LIMITATIONS OF REMEDIES SO THESE LIMITATIONS MAY NOT APPLY TO YOU.

If your spa is designated by Master Spas as a “Blem” or as “Blemished”, the Shell Surface is not warranted and the spa is purchased “As Is” regarding any cosmetic blemishes.



6927 Lincoln Parkway, Fort Wayne IN 46804
800 860 7727 masterspas.com



MICHAEL  PHELPS
LEGEND[®]



Customer Service: masterspas.com/resources

6927 Lincoln Parkway, Fort Wayne, IN 46804

800.860.7727 CustomerService@MasterSpas.com

Stay Connected, Keep in Touch



@MasterSpas

#masterspas

Manufactured and assembled in the U.S.A with domestic and foreign components. Master Spas[®] reserves the right to change product specifications or features without notice. Master Spas is a manufacturer of spas and related products, and we stand behind every product we produce pursuant to those representations which are stated in our written limited warranty. Your dealer is an independent businessperson or company and not an employee or agent of Master Spas, LLC. We cannot and do not accept any responsibility or liability for any other representations, statements, or contracts made by any dealer beyond the provisions of our written limited warranty. Master Spas, Michael Phelps Legend Series, Master Blaster, and EcoPur are registered trademarks of Master Spas, LLC. The Ultimate Relaxation Machine, Mast3rPur, DreamStone, and DuraMaster are all trademarks of Master Spas, LLC. Patents: masterspas.com/patents.

 Made in the USA
with U.S. and imported parts

POP25MPLOM REV. 03/2025